

RECORDING REQUESTED BY: CITY CLERK WHEN RECORDED RETURN TO: City Clerk City of Beaumont 550 E. 6th Street Beaumont, CA 92223	SPACE ABOVE THIS LINE FOR RECORDER'S USE
--	--

**CITY OF BEAUMONT
SUBDIVISION IMPROVEMENT AGREEMENT
TRACT or PARCEL NO. 31462-27**

DATE OF AGREEMENT: <u>January 28, 2025</u>		
NAME OF SUBDIVIDER: <u>Meritage Homes of California, Inc.</u> , a <u>California Corporation</u> . (hereinafter referred to as "Subdivider").		
NAME/NUMBER OF DEVELOPMENT: <u>31462-27</u> subdivision consisting of <u>68</u> residential lots, _____, originally approved on <u>9/22/23</u> , and Tentative Tract/Parcel _____ ("Tract/Parcel" or "Tentative Tract/Parcel Map"), originally approved on: _____.		
FINAL TRACT/PARCEL MAP _____ APPROVED ON _____ RECORDED ON _____ AS INSTRUMENT NUMBER _____ ("Final Tract Map/Final Parcel Map").		
PROPERTY SUBJECT TO AGREEMENT: The real property which is the subject of this Agreement is located in the City of Beaumont, County of Riverside and is described in Exhibit "A" attached hereto and incorporated herein (hereinafter the "Property").		
EST. TOTAL COST OF PUBLIC IMPROVEMENTS: \$ <u>237,228.90</u> (see Exhibit "B")	EST. TOTAL COST OF PRIVATE IMPROVEMENTS: \$ _____ (see Exhibit "B")	EST. TOTAL COST OF MONUMENTATION: \$ _____ (see Exhibit "B")
BOND NUMBERS: <u>024279664</u>		
LETTER OF CREDIT NUMBERS: _____		
FINANCIAL INSTITUTION: _____		

THIS SUBDIVISION IMPROVEMENT AGREEMENT (“Agreement”) is made and entered into by and between the City of Beaumont, a California municipal corporation (hereinafter referred to as “City”), and Meritage Homes of California, a California Corporation, (hereinafter referred to as “Subdivider”). City and Subdivider are sometimes referred to hereinafter individually as a “Party”, and collectively as the “Parties”.

RECITALS

A. Subdivider is the owner of certain real property located in the City of Beaumont legally described on Exhibit “A” attached hereto and incorporated and made part of this Agreement by this reference (the “Property”).

B. The conditions of approval of the above referenced Tentative Tract Map and any related entitlements, which are hereby incorporated herein by this reference, require that prior to the issuance of building permits, the Subdivider and the City shall enter into a subdivision improvement agreement, secured with sufficient security, as a guarantee of the construction and completion of all public and private improvements and land development work required by said conditions of approval and by the City subdivision laws and codes.

D. In consideration of the approval of a final map by the City Council, Subdivider desires to enter into this Agreement, whereby Subdivider promises to install and complete, at Subdivider's own expense, all the public improvement work required by City in connection with the proposed subdivisoion. Subdivider has secured this Agreement by improvement security required by the Subdivision Laws.

E. Improvement Plans (the “Plans”) for the construction, installation, and completion of the public and private improvements are being or have been prepared by Subdivider and will be subject to approval by the Director of Engineering/Public Works (“City Engineer”). The City has adopted standards (hereinafter “Standards”) for the construction and installation of improvements within the City, and the Plans will be prepared in conformance with the Standards in effect on the date of the approval of the Application. The Plans will be on file in the Office of the City Engineer and are incorporated into this Agreement by this reference as if set forth fully herein. All references in this Agreement to the Plans shall be deemed to include reference to any specifications for all of the improvements as approved by the City Engineer.

F. An estimate of the cost for construction of the public and private improvements and performing the land development work according to the Plans has been made and approved by the City Engineer. The estimated cost of these improvements is set forth on Page One (1) of this Agreement, and the basis for the estimate is attached hereto as Exhibit “B” and incorporated and made part of this Agreement by this reference. The amounts of the Improvement Securities required to be posted with this Agreement are also based upon the estimate in Exhibit “B”.

G. For the purposes of this Agreement, the term "Public Improvements" means all those improvements within the Tract/Parcel intended for transfer or conveyance to the City or other public agency. The estimated cost of their construction is included in the above estimate included herein as Exhibit "B".

NOW, THEREFORE, in consideration of the issuance of the Final Tract map, Subdivider and City hereby agree as follows:

1. **Subdivider's Obligation to Construct Improvements.**

(a) In constructing and installing the improvements, Subdivider shall comply with all of the requirements and conditions of approval of in the Tentative Tract Map, related entitlements as well as the provisions of the Municipal Code and Subdivision Laws.

(b) Subdivider shall complete, at its own expense, all the public and private improvements and related work on the Development, as required by the conditions of approval of the Tentative Map and related entitlements in conformance with the approved Plans and City Standards, including without limitation, those improvements set forth in Exhibit "B" (hereinafter collectively the "Improvements") within twenty-four (24) months of the date of this Agreement, unless a time extension is granted by the City as authorized by Section 20 of this Agreement.

(c) Notwithstanding the time limits specified in Section 1(b) above, no single family dwelling unit or group of units shall be given final inspection and clearance for occupancy by City unless the private and public streets providing access to and fronting such units are completed, the final lifts of pavement on the streets are in place, and all wet and dry utility services (e.g. sewer, water, electrical power, telephone, gas, etc.) to such units are in place and are operational.

(d) Subdivider shall furnish the necessary materials for completion of the Improvements in conformity with the Plans and City Standards.

(e) Subdivider shall acquire and dedicate, or pay the cost of acquisition by the City, of all rights-of-way, easements and other interests in real property required for construction or installation of the Improvements, free and clear of all liens and encumbrances. Subdivider's obligations relating to acquisition by City of off-site rights-of-way, easements and other interests in real property shall be subject to a separate agreement between Subdivider and City. Subdivider shall also be responsible for obtaining any public or private drainage easements or authorizations therefor to accommodate the Development.

(f) Subdivider shall furnish and install all monuments, stakes and property corners on the lots and streets in the Property as specified on the final recorded tract maps for the Development in accordance with the provisions of the Subdivision Laws, and shall submit centerline tie sheets to City, within thirty (30) days after completion of the Improvements, or as specified in any separate monument agreement with the City, but in any event prior to their acceptance by the City.

2. Improvement Securities.

(a) Subdivider agrees to secure this Agreement with good and sufficient improvement securities in a form approved by the City Attorney (referred collectively hereinafter as "Improvement Securities" and individually as "Improvement Security") to guarantee the construction and completion of all the improvements in the Development. All such improvement securities shall be posted with the City prior to the City's final building inspection and issuance of a Certificate of Occupancy for any single family dwelling constructed by Subdivider, its agents, assigns or contractors, on any lot within the Development, as described in Exhibit "A". Said securities are estimated at this time in Exhibit "B" to be in the following amounts, and shall be for the purposes described as follows:

(i) 237,228.90 and 00/100 DOLLARS (\$XXX,XXX.XX) to ensure faithful performance of the construction and installation of the public and private Improvements required by this Agreement ("Performance Security"), which amount is 100% of the estimated cost of the Improvements as set forth in Exhibit "B"; and

(ii) \$237,228.90 and 00/100 DOLLARS (\$XXX,XXX.XX) to secure payment to any contractor, subcontractor, persons renting equipment or furnishing labor materials for the Improvements required to be constructed or installed pursuant to this Agreement ("Labor & Materials Security"), which amount is one-hundred percent (100%) of the estimated cost of the Improvements; and

(iii) _____ and 00/100 DOLLARS (\$ XX,XXX.XX) in the form of a Warranty Bond or cash deposit with the City to guarantee or warranty the Improvement work done pursuant to this Agreement for a period of one (1) year following acceptance/certification thereof by City, against any defective work or labor done or defective materials furnished ("Warranty Security"). The Warranty Security is 10% of the estimated cost of the Performance Security amount described above, and such Warranty Security must be provided by Subdivider to City prior to the City's release of any bonds or Improvement Securities filed with this Agreement.

(iv) _____ and 00/100 Dollars (\$X,XXX.XX) in the form of a cash deposit, which is 100% of the estimated cost of setting all final subdivision monuments, boundary corners, front and rear lot corners and centerline ties not previously set or submitted on the lots and streets within the Property as described in Exhibit "A", and for the preparation and recordation of any related Certificate of Correction, as required by Section 66469 of the State Subdivision Map Act.

(b) The Improvement Securities required by this Agreement shall be kept on file with the City Clerk. If surety bonds are used, they must be issued by a surety company currently admitted to transact surety insurance business in California by the California Department of Insurance, with a Best's Insurance Guide rating of no less than A-. The terms of any documents evidencing such Improvement Securities as set forth in this Section 2 or

referenced on Page One (1) of this Agreement, are incorporated into this Agreement by this reference as if set forth fully herein. If any Improvement Security is replaced by another type or kind of approved Improvement Security, subject to the approval of the form thereof by the City Attorney, the replacement shall be filed with City Clerk and, upon filing, shall be deemed to have been made a part of and incorporated into this Agreement. Upon filing of a satisfactory replacement Improvement Security with the City Clerk, the former Improvement Security shall be released.

(c) Subdivider agrees to keep its Improvement Securities in full force and effect until they are reduced or released by City. If any Improvement Security provided by Subdivider is cancelled or terminated for any reason by the action of a surety, financial institution or other party, it shall be the responsibility of the Subdivider to immediately, upon written notice from City, provide a substitute Improvement Security which conforms to all the requirements of this Section 2 in the same amount or amounts.

(d) Any additions, changes, alterations, or modifications of this Agreement or to the Plans, Specifications and Improvements referred to herein, including any extension of time within which the work hereunder may be completed, shall not release or exonerate any surety or sureties on the Improvement Security given in connection with this Agreement.

3. Alterations to Improvement Plans; Modification of City Standards.

(a) Any changes, alterations or additions to the Plans or to the Improvements, not exceeding 10% of the original estimated cost of the Improvements, which are mutually agreed upon by City and Subdivider, shall not require Subdivider to increase any Improvement Securities provided under this Agreement. In the event such changes, alterations, or additions exceed 10% of the original estimated cost of the Improvements, Subdivider shall provide additional Performance Security as required by Section 2 of this Agreement for 100% of the total estimated cost of the Improvements as changed, altered, or amended, minus any completed partial releases allowed by Section 7 of this Agreement. Subdivider shall also provide additional Labor & Materials Security as required by Section 2 of this Agreement for 50 % of the total estimated cost of the Improvements as changed, altered, or amended.

(b) Subdivider shall construct all Improvements in a good and workman like manner and in accordance with the City Standards in effect as of the date of the Approval Action specified on Page One (1) hereof. The City reserves the right to modify the Standards applicable to the Subdivision and this Agreement, when necessary to protect the public safety or welfare or to comply with applicable State or Federal law or City zoning ordinances. If Subdivider requests and is granted an extension of time for completion of the Improvements, the City may apply the Standards in effect at the time the extension is granted.

4. Modification of Drainage Plan. Subdivider agrees that if during the course of construction and installation of Improvements it shall be determined by the City Engineer that revision of the

drainage plan is necessary in the public interest, it will undertake such design and construction changes as may be reasonable and as are indicated by the City Engineer and approved by City. Said changes, if any, shall be confined to the Property.

5. **Reserved.**

6. **Inspections; Final Acceptance and Certification of Improvements.**

(a) Subdivider shall at all times maintain proper facilities and safe access for inspection of the Improvements by City inspectors and to the shops wherein any work is in preparation.

(b) Upon completion of the Improvements covered in this Agreement, the Subdivider shall request a final inspection by the City Engineer or his/her authorized representative. Following receipt of such request, the City Engineer shall inspect the Improvements, make certain determinations and take certain actions as follows:

(i) If the City Engineer, or his/her authorized representative, determines that the Public Improvements requiring acceptance by another public agency have been completed in accordance with this Agreement, then the City Engineer shall request said agency to make a final inspection of such improvements and certify to the City that such improvements have been completed and installed to the satisfaction of said agency. Upon receipt of such certification, the City Engineer may release or reduce the securities held for such improvements. Any certification and/or acceptance of the Public Improvements shall not constitute a waiver of any defects by City.

(ii) For Improvements not requiring dedication to or acceptance by the a public agency (the "Private Improvements"), the City Engineer or his/her authorized representative shall inspect such improvements, and/or shall have the discretion to accept a certification from Subdivider's registered civil engineer stating that the Private Improvements have been completed in accordance with the approved Plans, City Standards and the Tentative Map. If the City Engineer, or his/her authorized representative, makes a finding, based on his/her own inspection (and/or any certification submitted by Subdivider's registered civil engineer) that the Private Improvements have been installed and constructed in accordance with the approved Plans, City Standards and the Tentative Map, the City Engineer shall recommend certification of the completion of the Private Improvements by placing an item on the next most convenient City Council agenda requesting certification and authorization to release the Improvement Securities. Said determination by the City Engineer and agendization of the certification and release shall not be unreasonably withheld or delayed.

(c) Subdivider shall bear all costs of inspection and certification of the Improvements.

7. Release of Improvement Securities.

(a) The Performance Security shall be fully released only upon the final completion and certification of all Private Improvements and Public Improvements. Partial releases may be permitted subject to the provisions of Subsections (a)(i) and (a)(ii) hereof. Upon final completion of the Public and Private Improvements under this Agreement, and after City Council acceptance/certification, the City shall file a Notice of Completion in accordance with the California Civil Code.

(i) The City Engineer may release a portion of the Performance Security, as work on the Improvements progresses, upon written application thereof by the Subdivider; provided, however, that no such release shall be considered by City for an amount less the cost estimate of the remaining work does not exceed twenty percent (20%) or less of the estimate of the total amount of work to be done as shown in Exhibit "B". Upon approval of a partial release or the reduction of Performance Security, the City shall not reduce such Performance Security to an amount less than two hundred percent (200%) of the value of the work remaining to be done. City and Subdivider agree that not more than two requests for reduction or partial release of Performance Security shall be considered between the start of construction and the completion and acceptance/certification of the Improvements by the City.

(ii) In no event shall the City Engineer authorize a release or reduction of the Performance Security which would reduce such security to an amount below that required to guarantee the completion of the Improvements and any other obligations imposed upon Subdivider by this Agreement.

(iii) No partial reduction or release of the Performance Security shall constitute or be construed as the City's acceptance or certification of any Improvements or related work. Such partial reductions or releases (if any) will merely reflect that a certain portion of the required work has been done.

(b) The Labor & Materials Security shall, ninety (90) days after the City's recordation of the Notice of Completion described in Subsection 7(a), be reduced to an amount equal to the total claimed by all claimants for whom liens have been filed and of which notice has been given to City, plus an amount reasonably determined by the City Engineer to be required to assure the performance of any other obligations secured by the Labor & Materials Security and to cover related legal costs. The balance shall be released upon the settlement of all claims and obligations for which the Labor & Materials Security was given. If no claims or liens have been filed and no notice has been given to City within said ninety (90) day period, then the Labor & Materials Security shall be released in full.

(c) The Warranty Security shall not be released until after the expiration of the one-year (1-year) warranty period and until any claims filed during the warranty period have been settled. As provided in Section 11, below, the warranty period shall not commence until final acceptance/certification of the Improvements and related work by the City Council.

(d) The Monumentation Security may be released in full by the City Engineer in accordance with the terms of the separate monument agreement with the City, or if there is none, upon submittal of the following:

(i) a written certification from the professional engineer or surveyor responsible for setting the monuments stating that all the final monuments for the Subdivision have been set in accordance with the Professional Land Surveyors Act and the Subdivision Map Act, and that the professional engineer or surveyor has been paid in full by Subdivider for such services; and

(ii) centerline tie sheets prepared in a manner acceptable to the City Engineer showing the locations of centerline monuments in existing public or private streets; and

(iii) any Record of Survey required by this Agreement has been filed with the County of Riverside and recorded.

(e) The City may retain from any Improvement Securities released an amount sufficient to cover costs and reasonable expenses and fees, including reasonable attorneys' fees.

8. Injury to Public Improvements, Public Property or Public Utilities Facilities.

Subdivider shall replace or repair or cause the repair or replacement of any and all public or private improvements, public utilities facilities and survey or subdivision monuments which are destroyed or damaged as a result of any work under this Agreement. Subdivider shall bear the entire cost of replacement or repairs of any and all public or private improvements or utility property damaged or destroyed by reason of any work done under this Agreement, whether such property is owned by the United States or any agency thereof, or the State of California, or any agency or political subdivision thereof, or by the City or any public or private utility corporation or by any combination of such owners. Any repair or replacement shall be made to the reasonable satisfaction, and subject to the approval of the City Engineer and the owner of any such public or private improvement.

9. Permits. Subdivider shall, at Subdivider's expense, obtain all necessary permits and licenses for the construction and installation of the Improvements, give all necessary notices and pay all fees and taxes required by law.

10. Notice of Breach/Default of Subdivider.

(a) Default of Subdivider shall include, but not be limited to: (1) Subdivider's failure to timely complete construction of the Improvements; (2) Subdivider's unwarranted failure to timely cure any defect in the Improvements; (3) Subdivider's failure to perform substantial construction work for a period of twenty (20) consecutive calendar days after commencement of the work; (4) Subdivider's insolvency, appointment of a receiver, or the filing of any petition in bankruptcy either voluntary or involuntary which Subdivider fails to discharge within thirty (30) days; (5) the commencement of a foreclosure action against the

Property or a portion thereof, or any conveyance in lieu or in avoidance of foreclosure; (6) Subdivider's failure to keep the Improvement Securities in full force and effect; (7) Subdivider's failure to notify the City of any sale, transfer or other disposition of the Property to a purported new Subdivider; (8) Subdivider's failure to maintain insurance; or (9) the failure of Subdivider or Subdivider's contractors, subcontractors, agents or employees to comply with any other terms and provisions of this Agreement.

(b) In the event of any such default, the City Engineer or the City Council may serve written notice to Subdivider specifying in reasonable detail the nature of the default. Subdivider shall have thirty (30) days from receipt of said notice to cure the default; provided that, if the default is not reasonably susceptible to being cured within said thirty (30) days, Subdivider shall have a reasonable period of time to cure the default so long as Subdivider commences to cure the default within said thirty (30) days and diligently prosecutes the cure to completion.

(c) If following service of such written notice of default, Subdivider fails to cure or commence curing the default to the satisfaction of City within the cure period specified in Subsection 10(b), above, the City Engineer or the City Council may serve notice of Subdivider's default upon Subdivider and where applicable Subdivider's surety, or the holder(s) of any other Improvement Securities, in accordance with the notice provisions set forth in Section 22 of this Agreement.

(d) In the event of service of the notice of default specified in Subsection 10(c), above, Subdivider's surety shall have the duty to take over and complete the Improvements and related work required under this Agreement; provided; however, that if the surety, within twenty (20) days after the serving upon it of such notice of default, does not give the City written notice of its intention to take over the construction of said Improvements or does not, within ten (10) days after giving City notice of such election, commence to complete the Improvements, City may take over the work and prosecute the Improvements to completion, by contract or by any other method City may deem advisable, for the account and at the expense of Subdivider, and Subdivider's surety shall be liable to City for any costs or damages occasioned City thereby; and, in such event, City, without liability for so doing, may take possession of, and utilize in completing the Improvements, such materials, appliances, plant and other property belonging to Subdivider as may be on the site of the work and necessary for the completion of same.

(e) The City reserves to itself all remedies available to it at law or in equity for Subdivider's default under this Agreement. The City shall have the right, subject to this Section, to draw upon or utilize the appropriate Improvement Securities to mitigate City's damages in event of default by Subdivider. The right of City to draw upon or utilize the Improvement Securities is additional to and not in lieu of any other remedy available to City. It is specifically recognized that the estimated costs and amounts of Improvement Securities may not reflect the actual cost of construction or installation of the Improvements, and therefore, City's damages for Subdivider's default shall be measured by the actual cost of completing the required Improvements. The sums provided by the

Improvement Securities may be used by City for the completion of the Improvements in accordance with the Plans.

(f) Failure of Subdivider to comply with the terms of this Agreement, including but not limited to, construction of all the Improvements as set forth herein and as required by the Tentative Map, shall constitute Subdivider's consent to: (1) the filing by City of a notice of violation against all of the lots in the Subdivision; (2) withholding of Building permits, utility connections and/or Certificates of Occupancy. The remedies provided by this Subsection (f) are in addition to and not in lieu of any other remedies available to City at law or in equity. Subdivider agrees that the choice of remedy or remedies for Subdivider's default or breach shall be in the sole discretion of City.

(g) In the event that Subdivider fails to perform any obligation hereunder, Subdivider agrees to pay all costs and expenses incurred by City in securing performances of such obligations, including costs of suit and reasonable attorney's fees.

(h) The failure of City to take an enforcement action with respect to a default, or to declare a default or breach, shall not be construed as a waiver of that default or breach, or of any subsequent default or breach of Subdivider. Any failure by the City to enforce any provision of this Agreement shall not be construed as a waiver of the right to compel enforcement of such provision(s) and further shall not act to release any surety from its obligations under this Agreement.

11. Warranty.

(a) For a period of one (1) year after final acceptance/certification by the City Council of the Improvements, Subdivider shall guarantee or warranty all the Improvements against any defective work or labor done or defective materials furnished. If within the warranty period any work relating to the Improvements or any part of thereof furnished, installed, constructed or caused to be done, furnished, installed or constructed by Subdivider fails to fulfill any of the requirements of this Agreement or the Plans, Subdivider shall without delay and without any cost to City, commence to repair or replace or reconstruct any defective or otherwise unsatisfactory part or parts of the work or structure within thirty (30) days of receiving written notice from City of the defect and diligently prosecute the repair or replacement work to completion.

(b) Should Subdivider fail to act promptly or in accordance with the repair/replacement requirements set forth herein, Subdivider hereby authorizes City, at City's option, to perform the repair/replacement work twenty (20) days after mailing written notice to Subdivider and to Subdivider's surety, and Subdivider agrees to pay City for the cost of such work.

(c) Should the City determine that an emergency or a threat to the public safety and welfare exists from the condition of the Improvements which require repairs, replacements or remedial measures to be made before Subdivider can be notified, City may, in its sole

discretion, make the necessary repairs or replacements or perform the necessary work and Subdivider shall pay to City the cost of such repairs.

12. Subdivider Not Agent of City. Neither Subdivider nor any of Subdivider's agents, officers, employees, or contractors are or shall be considered to be agents of City in connection with the performance of Subdivider's obligations under this Agreement.

13. Injury to Improvement Work; Risk of Loss. Until such time as the Public Improvements are accepted by City, Subdivider shall be responsible for and bear the risk of loss to any of the Public Improvements constructed or installed and shall be responsible for the care, maintenance of and any damage to such Public Improvements. Neither City, nor any of its agents, officers or employees shall be liable or responsible for any accident, loss or damage, regardless of cause, happening or occurring to the Public Improvements specified in this Agreement prior to the completion and acceptance of the Public Improvements by City. All such risks shall be the responsibility of and are hereby assumed by Subdivider. Subdivider is responsible for and shall bear the risk of loss for all Private Improvements at all times.

14. Other Agreements. Nothing contained in this Agreement shall preclude City from expending monies pursuant to agreements concurrently or previously executed between the Parties, or from entering into agreements with other Subdividers for the apportionment of costs of water and sewer mains, or other improvements, pursuant to the provisions of City ordinances providing therefor, nor shall anything in this Agreement commit to any such apportionment.

15. Subdivider's Obligation to Warn Public During Construction. Until final acceptance/certification of the Public Improvements pursuant to Section 6(b)(i), and final certification of construction of the Private Improvements pursuant to Section 6(b)(ii), Subdivider shall give good and adequate warning to the public of each and every dangerous condition existent in said Improvements and will take all reasonable actions to protect the public from such dangerous conditions in, on or around the work site.

16. Vesting of Ownership. Upon acceptance of the Public Improvements and related work on behalf of the City, and after recordation of the Notice of Completion, ownership of the Public Improvements constructed within the Private streets in the Development shall vest in the name of the City, or applicable government agency or utility company, and any improvement constructed on any public street pursuant to this Agreement shall vest in City.

17. Indemnity/Hold Harmless.

(a) Neither the City, nor any official, officer, employee, contractor or agent thereof, shall be liable for any injury to persons or property occasioned by reason of the acts or omissions of Subdivider, its agents, subcontractors or employees in the performance of this Agreement. Subdivider hereby agrees to, and shall defend and hold harmless City, its elective and appointive boards, commissions and officers, and its agents, contractors and employees from and against any and all claims, demands, causes of action, damages, costs, expenses, actual attorneys' fees, consultant's fees, expert's fees, losses or liability, in law or in equity, of every kind and nature whatsoever arising out of or in connection with

Subdivider's operations, or any subcontractor's operations, to be performed under this Agreement for Subdivider's or subcontractor's tort negligence including active or passive, or strict negligence, including but not limited to personal injury including, but not limited to bodily injury, emotional injury, sickness or disease, or death to persons and/or damage to property of anyone, including loss of use thereof, caused or alleged to be caused by any act or omission of Subdivider or any subcontractor, or anyone directly or indirectly employed by any of them or anyone for the full period of time allowed by law, with the exception of the sole negligence or willful misconduct of City.

(b) Subdivider's indemnity, defense and hold harmless obligations under this Section 17 are not conditioned or dependent upon whether City, or its elective and appointive boards, commissions and officers, or its agents, contractors and employees, prepared, supplied or reviewed any Plans or related specifications in connection with the Improvements, or whether City or Subdivider has insurance or other indemnification covering any of these matters.

(c) Subdivider's obligation to indemnify, hold harmless and defend City shall extend to injuries to persons and damages to or alleged taking of property resulting from the design or construction of the Improvements. City's acceptance and/or certification of the Improvements shall not constitute an assumption by City of any responsibility or liability for any damage or alleged taking of property referenced herein. City shall not be responsible or liable for the design or construction of the Improvements constructed or installed pursuant to the Plans, unless the particular Improvement design was required by City over the written objection of Subdivider, which objection stated that the Improvement design was potentially dangerous or defective and set forth a safe and feasible alternative design. After City's acceptance/certification of the Improvements, Subdivider shall remain obligated to correct or eliminate all dangerous conditions caused by defects in design or construction; provided, however, that the Subdivider shall not be responsible for routine maintenance. Subdivider acknowledges and agrees that Subdivider shall be responsible and liable for the design and construction of the Improvements and other work done pursuant to this Agreement, and except as may be provided above, City shall not be liable for any acts or omissions in approving, reviewing, checking, correcting or modifying any Plans, or in inspecting, reviewing or approving any work or construction of Improvements. Subdivider's Improvement Securities shall not be required to secure Subdivider's obligations under this Section 17.

18. Sale or Disposition of Subdivision; Assignment.

(a) Subdivider acknowledges and agrees that sale, transfer or other disposition of the Property prior to completion of the Improvements required hereunder will not relieve Subdivider from the obligations set forth in this Agreement, and Subdivider shall be required to notify City sixty (60) days in advance of any sale or transfer of ownership of the Property or any proposed assignment of this Agreement. If Subdivider sells or otherwise transfers the Property to any other person or entity prior to final completion of the Improvements, or wishes to assign this Agreement, Subdivider may request a novation of this Agreement and a substitution of Improvement Securities by the new owner or proposed

assignee (hereinafter collectively for purposes of this Section, "Successor"). Subdivider shall be required to provide any documentation reasonably required by City to determine the appropriateness of any proposed Successor.

(b) Any proposed Successor must demonstrate to the City its ability to perform and complete the obligations of Subdivider under this Agreement, as determined by objective standards of financial capability, creditworthiness and experience required for such performance, and the City shall have the right to compel the Successor to disclose all documents, information and other material which, in City's sole reasonable discretion, may establish or tend to establish that the proposed Successor meets the standards specified herein. Following approval by City and full execution of a novation (or other such release or assignment and assumption agreement(s) entered into by Subdivider, Successor and City), posting of satisfactory Improvement Securities and submission of required insurance by Successor, City shall release or reduce the securities posted by Subdivider in accordance with the provisions of such novation and release Subdivider of its obligations under this Agreement. Nothing in the novation (or other such release or assignment and assumption agreement entered into by Subdivider, Successor and City) shall relieve Subdivider of its obligations under any other Section of this Agreement for work or Improvements performed by Subdivider prior to the novation.

19. Time of the Essence. Time is of the essence in this Agreement.

20. Time for Completion of Improvements; Extensions.

(a) Subdivider shall commence and diligently prosecute to completion construction of all the Improvements required by this Agreement. The time for completion of the Improvements as specified in Subsection 1(b) of this Agreement may be extended as permitted by City ordinance. The City Manager may grant an extension of time for such period as may be in the public interest upon the showing of the Subdivider of good cause. Any such extension granted shall be subject to the limitations and conditions set forth in Subsections 20(b) and (c), below, and shall be made by a writing executed by the in a form as approved by the City Attorney.

(b) Any such extension may be granted without notice to Subdivider's surety and shall not affect the validity of this Agreement or release the surety or sureties on any Improvement Securities given for this Agreement. However, City reserves the right to require as part of any extension amendment a written assurance from the surety acceptable to the City Attorney that the Improvement Securities required by Section 2 of this Agreement shall remain enforceable throughout the term of any extension.

(c) The City Manager shall be the sole and final judge as to whether or not good cause has been shown to entitle Subdivider to an extension. In addition, the time for completion of the Improvements shall be extended for any delay resulting from an act of City, or from an act of God, which Subdivider could not have reasonably foreseen, or by storm or inclement weather which prevents the conducting of work, or by strikes, boycotts, similar actions by employees or labor organizations, which prevent the conducting of work, and

which were not caused by or contributed to by Subdivider, provided that Subdivider provides City with written notice of the delaying event within fifteen (15) days of the commencement of the delay. In the event of such delaying event, Subdivider shall use all reasonable efforts to remedy same and resume completion of the Improvements as promptly as practicable.

(d) As a condition of granting an extension of time to complete the Improvements required by this Agreement, the City Manager may require Subdivider to furnish new or additional Improvement Securities guaranteeing performance of this Agreement as extended in an increased amount as necessary to compensate for any increase in construction costs as determined by the City Engineer.

21. Notice. All notices required by or provided for under this Agreement shall be in writing and delivered in person or sent by certified or registered mail, postage prepaid and addressed as provided in this Section. Notice shall be effective on the date it is delivered in person, or, if mailed, on the date of deposit in the United States Mail. Notices shall be addressed as follows unless a written change of address is filed with City:

Notice to City: City of Beaumont
550 E. 6th Street
Beaumont, CA 92223

Attn: City Manager

With a Copy to: John Pinkney, Esq.
SBEMP
1800 East Tahquitz Canyon Way
Palm Springs, CA 92262

Notice to Subdivider:

22. Severability. The provisions of this Agreement are severable. If any portion of this Agreement is held invalid by a court of competent jurisdiction, the remainder of the Agreement shall remain in full force and effect unless amended or modified in writing by the mutual consent of the Parties.

23. Captions. The captions of this Agreement are for convenience and reference only and shall not define, explain, modify, limit, exemplify, or aid in the interpretation, construction or meaning of any provisions of this Agreement.

24. Insurance.

(a) Subdivider shall, at all times during the construction of the Improvements, obtain, carry, maintain, and keep in full force and effect, at its sole cost and expense, policies of insurance of the types and in at least the minimum amounts described below:

(i) Commercial General Liability policy with a minimum combined single limit of One Million Dollars (\$1,000,000) for each occurrence and Two Million Dollars (\$2,000,000) in the aggregate for bodily injury, death, personal injury and property damage arising out of or in connection with the activities of the Subdivider and its contractors and subcontractors in performance of the work under this Agreement. Coverage shall be at least as broad as Insurance Services Office Commercial General Liability coverage (Occurrence Form CG 0001) and shall, in addition to the other coverages specified in this subsection, include coverage for independent contractors, ongoing operations, products and completed operations, contractual liability and personal and advertising injury.

(ii) Commercial Vehicle/Automotive Liability policy covering personal injury and property damage, with minimum limits of One Million Dollars (\$1,000,000) per occurrence, combined single limit, covering any vehicle utilized by Subdivider, its officers, agents, employees, subcontractors or independent contractors in performing the work required by this Agreement.

(iii) Workers' Compensation and Employer's Liability policy for all Subdivider's employees, with Workers' Compensation limits as required by State law and Employer's Liability coverage of \$1,000,000 per accident for bodily injury or disease. In case any work is sublet, Subdivider shall require any contractor or subcontractor similarly to provide Workers' Compensation and Employer's Liability Insurance for all contractor's or subcontractor's employees, unless such employees are covered by the protection afforded by Subdivider.

(1) In case any class of employees engaged in work under this Agreement at the work site(s) is not protected under any Workers' Compensation law, Subdivider shall provide and shall cause each contractor or subcontractor to provide, adequate insurance for the protection of employees not otherwise protected.

(2) Subdivider hereby indemnifies City for any damages or claims resulting from failure of either Subdivider or any contractor or subcontractor to take out or maintain such liability or Workers' Compensation insurance.

(b) Insurer Rating; Acceptability. Except as set forth otherwise herein, the policies required by this Section shall be issued by a California-admitted insurer with a rating of at least a A-; VII in the latest edition of Best's Insurance Guide. A Commercial General Liability policy issued by an insurer that is on the California Department of Insurance's List of Approved Surplus Line Insurers ("LASLI") will be acceptable, if no coverage from an

admitted insurer can be obtained by Subdivider, and further provided that such insurer maintains a Best's rating of at least "A-; X" and remains on the LASLI during the term hereof. Workers' Compensation coverage issued by the State Compensation Insurance Fund shall be acceptable if no other coverage can be obtained by Subdivider, and further provided such insurer remains admitted in California and is otherwise financially acceptable to City.

(c) Deductibles. Any deductibles or self-insured retentions must be declared in writing by Subdivider to City and subsequently approved by City prior to its execution of this Agreement and prior to commencement of any work hereunder. At City's option, Subdivider shall either reduce or eliminate the deductibles or self-insured retentions with respect to City, or Subdivider shall procure a bond guaranteeing payment of losses and expenses.

(d) Certificates and Endorsements Verification. Subdivider shall submit to the City original certificates of insurance and endorsements evidencing the coverages required by this Section. The certificates and endorsements for each insurance policy shall be signed by a person authorized by that insurer to bind coverage on its behalf. The City reserves the right to require complete, certified copies of all required insurance policies at any time and/or to require Subdivider to provide reports or status updates to evidence compliance of its contractors and subcontractors with the provisions of this Section.

(e) Required Endorsements.

(i) The Commercial General Liability and Commercial Vehicle/Automotive Liability policies are to contain or be endorsed to contain the following provisions:

(1) Additional Insureds. The City of Beaumont, its officials, officers, employees, agents and independent contractors shall be named as additional insureds with respect to liability arising out of automobiles owned, leased, hired or borrowed by or on behalf of the Subdivider; and with respect to liability arising out of work or operations performed by or on behalf of the Subdivider including materials, parts or equipment furnished in connection with such work or operations.

(2) Primary Insurance. For any claims related to this project, the Subdivider's insurance coverage shall be primary insurance as respects the City of Beaumont, its officials, officers, employees, agents and independent contractors. Any insurance or self-insurance maintained by the City of Beaumont, its officials, officers, employees, agents and independent contractors shall be excess of the Subdivider's insurance and shall not contribute with it. This endorsement is not applicable to the Commercial Vehicle/Automotive Liability Policy.

(3) Waiver of Subrogation. Endorsements waiving all rights of subrogation against the City of Beaumont, its officials, officers, employees, agents and independent contractors shall be provided.

(ii) The Workers' Compensation policy shall be endorsed to waive all rights of subrogation against the City of Beaumont, its officials, officers, employees, agents and independent contractors.

(f) Other Insurance Requirements. All policies required under this Agreement shall contain provisions stating that such policies cannot be canceled or reduced except on at least thirty (30) days prior written notice to Subdivider (ten (10) days' notice for cancellation due to non-payment). Subdivider further agrees to: (1) provide to City copies of any notices relating to cancellation or reduction of insurance within two (2) days of receipt; and (2) cause all certificates of insurance to include language indicating that the issuers or producers of such policies will endeavor to provide copies of any such notices directly to City.

(g) Commencement of Work. Subdivider shall not commence work under this Agreement until Subdivider has obtained all insurance required pursuant to this Section, and such insurance has been obtained by Subdivider and approved by City; nor shall Subdivider allow any contractor or subcontractor to commence work on the Improvements until all similar insurance required of the contractor or subcontractor has been obtained. Certificates, endorsements, and where applicable, full copies of policies shall be maintained on file with the City Clerk.

(h) Higher Limits. If Subdivider maintains higher limits than the minimums specified in this Section 25, the City requires and shall be entitled to coverage for the higher limits maintained by Subdivider. Any available insurance proceeds in excess of the specified minimum limits of insurance and coverage shall be available to the City.

25. Attorneys' Fees. In the event any action at law or in equity is brought to enforce the terms of this Agreement, the prevailing Party shall be entitled to litigation costs and reasonable attorneys' fees.

26. Incorporation of Recitals. The Recitals to this Agreement are hereby incorporated into in the terms of this Agreement.

27. Entire Agreement. This Agreement constitutes the entire agreement of the Parties and supersedes any prior written or oral agreements between them with respect to the subject matter hereof. All modifications, amendments, or waivers of the terms of this Agreement must be in writing and signed by the appropriate representatives of the Parties.

28. Governing Law; Venue. This Agreement shall be governed by and interpreted in accordance with the laws of the State of California. In the event that suit shall be brought by either Party to this contract, the Parties agree that venue shall be exclusively vested in the State courts

of the County of Riverside, California or where appropriate, in the United States District Court, Southern District of California, Riverside, California.

29. Runs with the Land; Recordation.

(a) The Parties agree that the terms and provisions set forth in this Agreement shall be deemed provisions, terms and/or covenants running with the Property in accordance with applicable law, including without limitation, California Civil Code section 1468, and shall pass to and be binding upon the heirs, successors and assigns of the Parties to this Agreement, and on any successor owner of the Property.

(b) The provisions of Subsection 29(a) notwithstanding, Subdivider shall remain jointly and severally liable with its heirs, successors, assigns or successor owners of the Property for the responsibilities and liabilities imposed by this Agreement unless a novation or assignment agreement is executed in accordance with the provisions of Section 18 of this Agreement.

(c) Upon execution, this Agreement shall be recorded in the Official Records of Riverside County, and by such recordation, it is the intention of the Parties to give notice to and bind their successors, heirs and assigns hereto.

30. Authority of Executing Parties. Each person executing this Agreement on behalf of a Party represents and warrants that such person is duly and validly authorized to do so all behalf of the entity it purports to bind and that he/she is authorized to enter into contracts on behalf of Subdivider. The undersigned, on behalf of Subdivider, binds Subdivider, its partners, successors, executors, administrators, and assigns with respect to the terms and provisions of this Agreement.

IN WITNESS WHEREOF, this Agreement is executed by the Parties hereto on the date above first written.

Subdivider:

Meritage Homes of California, Inc.
a California Corporation

City:

CITY OF BEAUMONT
a Municipal Corporation

Signature:  _____

Signature: _____
City Manager

Print Name: Mike Emsich

ATTEST:

City Clerk

APPROVED AS TO FORM:

John Pinkney, City Attorney

APPROVED AS TO CONTENT:

Robert Vestal, Dir. Of Engineering/Public Works

- | | |
|------------------------|---|
| Attachments: Exhibit A | Legal description of Property |
| Exhibit B | Cost estimate(s) |
| Exhibit C | Performance & Payment Bond OR Cash Bond |

(Proper Notarization of Subdivider's Signature is required and shall be attached)

CALIFORNIA ACKNOWLEDGMENT

CIVIL CODE § 1189

A notary public or other officer completing this certificate verifies only the identity of the individual who signed the document to which this certificate is attached, and not the truthfulness, accuracy, or validity of that document.

State of California

County of Orange

On January 28, 2025 before me, Jonathan Paul Fang
Date Here Insert Name and Title of the Officer

personally appeared Nick Emsiek
Name(s) of Signer(s)

who proved to me on the basis of satisfactory evidence to be the person(s) whose name(s) are subscribed to the within instrument and acknowledged to me that he/she/they executed the same in his/her/their authorized capacity(ies), and that by his/her/their signature(s) on the instrument the person(s), or the entity upon behalf of which the person(s) acted, executed the instrument.



I certify under PENALTY OF PERJURY under the laws of the State of California that the foregoing paragraph is true and correct.

WITNESS my hand and official seal.

Signature [Handwritten Signature]
Signature of Notary Public

Place Notary Seal and/or Stamp Above

OPTIONAL

Completing this information can deter alteration of the document or fraudulent reattachment of this form to an unintended document.

Description of Attached Document

Title or Type of Document: _____

Document Date: _____ Number of Pages: _____

Signer(s) Other Than Named Above: _____

Capacity(ies) Claimed by Signer(s)

Signer's Name: _____

- Corporate Officer – Title(s): _____
- Partner – Limited General
- Individual Attorney in Fact
- Trustee Guardian or Conservator
- Other: _____

Signer is Representing: _____

Signer's Name: _____

- Corporate Officer – Title(s): _____
- Partner – Limited General
- Individual Attorney in Fact
- Trustee Guardian or Conservator
- Other: _____

Signer is Representing: _____

EXHIBIT "A"

LEGAL DESCRIPTION

THE LAND REFERRED TO HEREIN BELOW IS SITUATED IN THE CITY OF BEAUMONT, IN THE COUNTY OF RIVERSIDE, STATE OF CALIFORNIA, AND IS DESCRIBED AS FOLLOWS:

TRACT NO. 31462-27, BEING A DIVISION OF PARCEL 4 OF PARCEL MAP NO. 38953, IN THE CITY OF BEAUMONT, COUNTY OF RIVERSIDE, STATE OF CALIFORNIA, RECORDED IN BOOK _____, PAGES _____ THROUGH _____, INCLUSIVE OF PARCEL MAPS, RECORDS OF SAID COUNTY.

EXCEPTING THEREFROM THE ABOVE PARCEL ANY AND ALL NATURAL OIL, OIL RIGHTS, MINERALS, MINERAL RIGHTS, NATURAL GAS, NATURAL GAS RIGHTS AND OTHER HYDROCARBONS BY WHATSOEVER NAME KNOWN AND ALL RIGHTS THEREIN, GEOTHERMAL STEAM, AND ALL PRODUCTS DERIVED FROM ANY OF THE FOREGOING, THAT MAY BE WITHIN OR UNDER THE LAND, TOGETHER WITH THE PERPETUAL RIGHT OF DRILLING, MINING, EXPLORING AND OPERATING THEREFOR AND STORING IN AND REMOVING THE SAME FROM THE LAND OR ANY OTHER PROPERTY, INCLUDING THE RIGHT TO WHIPSTOCK OR DIRECTIONALLY DRILL AND MINE FROM PROPERTY OTHER THAN THE LAND, OIL OR GAS WELLS, TUNNELS AND SHAFTS INTO, THROUGH OR ACROSS THE SUBSURFACE OF THE LAND, AND TO BOTTOM SUCH WHIPSTOCKED OR DIRECTIONALLY DRILLED WELLS, TUNNELS AND SHAFTS UNDER AND BENEATH OR BEYOND THE EXTERIOR LIMITS THEREOF, AND TO REDRILL, RETUNNEL, EQUIP, MAINTAIN, REPAIR, DEEPEN AND OPERATE ANY SUCH WELLS, TUNNELS OR SHAFTS, WITHOUT THE RIGHT TO DRILL, MINE, STORE OR EXCAVATE THROUGH THE SURFACE OR THE UPPER 500 FEET OF THE SUBSURFACE OR THE LAND AS RESERVED BY OAK VALLEY PARTNERS, L.P., A TEXAS LIMITED PARTNERSHIP WHICH IS REGISTERED IN CALIFORNIA AS OVP, L.P., IN A GRANT DEED RECORDED NOVEMBER 14, 2003 AS [INSTRUMENT NO. 2003-899365 OF OFFICIAL RECORDS](#).

ANY AND ALL WATER, WATER RIGHTS OR INTERESTS THEREIN APPURTENANT OR RELATING TO THE LAND OR OWNED OR USED BY GRANTOR IN CONNECTION WITH OR WITH RESPECT TO THE LAND (NO MATTER HOW ACQUIRED BY GRANTOR), WHETHER SUCH WATER RIGHTS SHALL BE RIPARIAN, OVERLYING, APPROPRIATIVE, LITTORAL, PERCOLATING, PRESCRIPTIVE, ADJUDICATED, STATUTORY OR CONTRACTUAL, TOGETHER WITH THE RIGHT AND POWER TO EXPLORE, DRILL, REMOVE AND RESTORE THE SAME FROM OR IN THE LAND OR TO DIVERT OR OTHERWISE UTILIZE SUCH WATER, RIGHTS OR INTERESTS ON ANY OTHER PROPERTY OWNED BY OR LEASED BY GRANTOR, WITHOUT THE RIGHT TO ENTER UPON THE SURFACE OF THE LAND IN THE EXERCISE OF SUCH RIGHTS; PROVIDED, HOWEVER, ONLY IF AND TO THE EXTENT THAT SUCH RIGHTS ARE NOT USED BY GRANTEE IN ITS USE AND ENJOYMENT OF THE LAND AS RESERVED BY OAK VALLEY PARTNERS, L.P., A TEXAS LIMITED PARTNERSHIP, WHICH IS REGISTERED IN CALIFORNIA AS OVP, L.P., IN A GRANT DEED RECORDED NOVEMBER 14, 2003 AS [INSTRUMENT NO. 2003-899365 OF OFFICIAL RECORDS](#).

PORTION OF [APN: 413-790-74](#)

CITY OF BEAUMONT PUBLIC WORKS DEPARTMENT
CONSTRUCTION COST WORKSHEET

Approved
NV5
12/03/2024

PARCEL MAP OR TRACT NO.: TRACT 31462-27 Sewer
DATE: 11-Jun-24

PP, CUP NO.: _____ BY: Meritage Homes

IMPROVEMENTS FAITHFUL PERFORMANCE 100%
LABOR & MATERIALS SECURITY 100%
(of Estimated Construction Costs)

Streets/Drainage	\$	-
Sewer	\$	237,228.90
Total	\$	237,228.90
Warranty Retention (10%)	\$	23,722.89

Street/Drainage Plan Check Fees = _____
Sewer Plan Check Fees = _____
Street Inspection Fees = _____
Sewer Inspection Fees = _____

DESIGN ENGINEERS CALCULATIONS OF IMPROVEMENT BONDING COSTS

Construction items and their quantities as shown on attached sheets are accurate for the improvements required to construct the above project and the mathematical extensions using City's unit costs are accurate for determining bonding, plan check and inspection costs.

Above amounts do include additional 20% for recordation prior to having signed plans

Above amounts do not include additional 20% for recordation prior to having signed plans

Engineer's Signature

11-Jun-24
Date

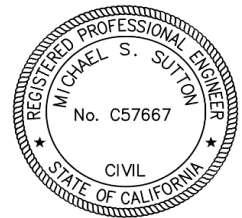

Michael Sutton
Name typed or printed

Civil Engineer's Stamp

FORM \$ UNIT COSTS REVISED 09/06

*******PLEASE READ INSTRUCTIONS BELOW*******

- Quantities to be taken from improvement plans, Unit costs to be as provided on "City of Beaumont Improvement Requirement Worksheet".
- Show Bond Amounts to the nearest \$500.
- For construction items not covered by "City of Beaumont Improvement Worksheet", Design Engineer is to provide his opinion of construction cost and use of that cost. If City of Beaumont Unit Costs are determined to be too low in the opinion of the Design Engineer, the higher costs as provided by the Design Engineer should be used.

CITY OF BEAUMONT PUBLIC WORKS DEPARTMENT
IMPROVEMENT REQUIREMENT WORKSHEET

PROJECT: TRACT 31462-27 Sewer

DATE: 11-Jun-24

STREET IMPROVEMENTS				
QTY.	UNIT	ITEM	UNIT COST	AMOUNT
		Roadway Excavation		
	C.Y.	1. Projects with a grading plan area x 0.50' (hinge point to hinge point)(xx sf)	\$ 15.00	\$ -
		2. Projects without a grading plan (road area and side slopes to daylight Cut (C) = Fill (f) =		
	C.Y. (c or f)	(a.) Excavate and Fill	\$ 0.40	\$ -
	C.Y. (f - c)	(b.) Excavate and Export	\$ 1.10	\$ -
		(c.) Import and Fill	\$ 2.80	\$ -
		If balance, provide (a.) only, either cut or fill		
		If export, provide (a.) & (b.), a = fill, b = cut - fill		
		If import, provide (a.) & (c.), a = cut, c= fill - cut		
		(Unit costs for (a.), (b.) & (c.) are 20% of actual costs to assure that work will be corrected to eliminate hazardous conditions.)		
	S.F.	Grinding A.C. in place	\$ 1.00	\$ -
	S.F.	Remove A.C. Pavement	\$ 1.00	\$ -
	L.F.	Remove Curb and Gutter	\$ 6.00	\$ -
	L.F.	Remove A.C. Dike	\$ 3.00	\$ -
	S.F.	Remove Sidewalk	\$ 3.00	\$ -
	L.F.	Sawcut & Remove Exist. A.C. Pavement	\$ 2.00	\$ -
	S.F.	Cold Plane A.C. Pavement	\$ 1.00	\$ -
	E.A.	Relocate Mailbox	\$ 250.00	\$ -
				\$ -
				\$ -
				\$ -
				\$ -
				\$ -
				\$ -
				\$ -
				\$ -
				\$ -
				\$ -
				\$ -
				\$ -
				\$ -

CITY OF BEAUMONT PUBLIC WORKS DEPARTMENT
IMPROVEMENT REQUIREMENT WORKSHEET

PROJECT: TRACT 31462-27 Sewer

DATE: 11-Jun-24

STREET IMPROVEMENTS (Cont'd.)				
QTY.	UNIT	ITEM	UNIT COST	AMOUNT
	L.F.	Remove Chain Link Fence	\$ 2.50	\$ -
	EA.	Remove Barricade	\$ 200.00	\$ -
	TON	Asphalt Concrete - 144 lbs/cu. Ft. (On-Site SF @ AC thickness Ft.)	\$ 90.00	\$ -
	C.Y.	Aggregate Base Class II (OnSite SF @ AB thickness Ft.)	\$ 50.00	\$ -
	TON	Asphalt Emulsion (Fog Seal/Paint Binder) (1 ton = 240 gals) (OnSite SF) apply at 0.05 + 0.03 = 0.08 gal/SY	\$ 600.00	\$ -
	S.F	AC overlay (min. 0.10') If export, provide (a) & (b), a=fill, b=cut-fill If import, provide (a)&(C), a=cut, c=fill-cut (Unit costs for (a), (b) & (C) are 20% of actual costs to assure that work will be corrected to eliminate hazardous conditions.)	\$ 1.00	\$ -
	L.F.	Curb and Gutter (Wedge Curb)	\$ 8.00	\$ -
	L.F.	Curb and Gutter (Type A-6)	\$ 10.00	\$ -
	L.F.	Curb and Gutter (Type A-8)	\$ 12.00	\$ -
	L.F.	Type "C" Curb	\$ 10.00	\$ -
	L.F.	Type "D" Curb	\$ 15.00	\$ -
	L.F.	A.C. Dike (6") (incl. material & labor)	\$ 8.00	\$ -
	L.F.	A.C. Dike (8") (incl. Material & labor)	\$ 10.00	\$ -
	S.F.	P.C.C. Cross Gutter and Spandrels	\$ 10.00	\$ -
	S.F.	P.C.C. Sidewalk	\$ 6.00	\$ -
	S.F.	P.C.C. Drive Approach	\$ 8.00	\$ -
	EA.	Handicapped Access Ramp	\$ 1,500.00	\$ -
	S.F.	P.C.C. Drive Approach (individual lot driveway approach per finished grading plan)	\$ 8.00	\$ -
	S.F.	Cold Plane & Overlay Exist. A.C. Paving	\$ 4.00	\$ -
				\$ -
				\$ -
				\$ -

CITY OF BEAUMONT PUBLIC WORKS DEPARTMENT
IMPROVEMENT REQUIREMENT WORKSHEET

PROJECT: TRACT 31462-27 Sewer

DATE: 11-Jun-24

STREET IMPROVEMENTS (Cont'd.)				
QTY.	UNIT	ITEM	UNIT COST	AMOUNT
	EA.	Street Name Sign	\$ 275.00	\$ -
	EA.	Delineators-per Caltrans Std. A73C, Class 1, Type F	\$ 45.00	\$ -
	EA.	Object Markers - Modified Type F Delineators, Riverside County	\$ 60.00	\$ -
	L.F.	Barricades	\$ 28.00	\$ -
	L.F.	Utility Trench, one side (Edison, Telephone, Cable) (Total length of streets)	\$ 10.00	\$ -
	L.F.	Chain Link Fence (6')	\$ 12.00	\$ -
	L.F.	Remove Fence	\$ 4.00	\$ -
	EA.	Relocate Power Pole	\$ 10,000.00	\$ -
	EA.	Street Lights (including conduit)	\$ 5,000.00	\$ -
	EA.	Street Trees (15 gallon)	\$ 150.00	\$ -
	L.S.	Landscape and Irrigation	\$ -	\$ -
	EA.	Concrete Bulkhead	\$ 200.00	\$ -
	C.Y.	Structural Reinforced Concrete	\$ 400.00	\$ -
	EA.	Slope Anchors for Pipes	\$ 300.00	\$ -
	L.F.	Cut Off Wall (Std. 2')	\$ 5.50	\$ -
	EA.	A.C. Overside Drain	\$ 500.00	\$ -
	EA.	Under Sidewalk Drain Std. 309	\$ 2,000.00	\$ -
	EA.	Flat Outlet Drainage Structure Std. 303	\$ 500.00	\$ -
	EA.	Curb Outlet Drainage Structure Std. 308	\$ 500.00	\$ -
	S.F.	Terrace Drains and Down Drains	\$ 6.50	\$ -
	S.F.	Interceptor Drains	\$ 6.50	\$ -
	EA.	"STOP" Pavement Marking	\$ 200.00	\$ -
	L.F.	Limit Line	\$ 2.00	\$ -
	EA.	R1 "STOP SIGN"	\$ 250.00	\$ -
	EA.	W53 "NOT A THROUGH STREET"	\$ 250.00	\$ -
				\$ -

CITY OF BEAUMONT PUBLIC WORKS DEPARTMENT
IMPROVEMENT REQUIREMENT WORKSHEET

PROJECT: TRACT 31462-27 Sewer

DATE: 11-Jun-24

STREET IMPROVEMENTS (Cont'd.)				
QTY.	UNIT	ITEM	UNIT COST	AMOUNT
	C.Y.	Rip Rap (1/4 Ton) Method B	\$ 40.00	\$ -
	C.Y.	Rip Rap (1/2 Ton) Method B	\$ 45.00	\$ -
	C.Y.	Rip Rap (1 Ton) Method B	\$ 50.00	\$ -
	C.Y.	Rip Rap (2 Ton) Method B	\$ 55.00	\$ -
	C.Y.	Grouted Rip Rap (1/4 Ton) Method B	\$ 60.00	\$ -
	C.Y.	Grouted Rip Rap (1/2 Ton) Method B	\$ 67.00	\$ -
	C.Y.	Grouted Rip Rap (1Ton) Method B	\$ 75.00	\$ -
	C.Y.	Grouted Rip Rap (2 Ton) Method B	\$ 80.00	\$ -
	L.F.	18" R.C.P.	\$ 60.00	\$ -
	L.F.	24" R.C.P.	\$ 70.00	\$ -
	L.F.	30" R.C.P.	\$ 80.00	\$ -
	L.F.	36" R.C.P.	\$ 90.00	\$ -
	L.F.	42" R.C.P.	\$ 100.00	\$ -
	L.F.	48 " RCP	\$ 110.00	\$ -
	L.F.	54" RCP	\$ 135.00	\$ -
	L.F.	60" RCP	\$ 160.00	\$ -
	L.F.	72" RCP	\$ 200.00	\$ -
	EA.	H.D.P.E. Clean Out	\$ 400.00	\$ -
	EA.	Drain Basin	\$ 400.00	\$ -
	EA.	Curb Outlet	\$ 3,000.00	\$ -
	EA.	Fossil Filters	\$ 500.00	\$ -
	EA.	18" C.M.P. Wye	\$ 500.00	\$ -
	EA.	Riprap Headwall	\$ 1,000.00	\$ -
	EA.	Concrete Collar	\$ 250.00	\$ -
	EA.	Outlet Structure	\$ 10,000.00	\$ -
				\$ -
				\$ -
				\$ -

CITY OF BEAUMONT PUBLIC WORKS DEPARTMENT
IMPROVEMENT REQUIREMENT WORKSHEET

PROJECT: TRACT 31462-27 Sewer

DATE: 11-Jun-24

STREET IMPROVEMENTS (Cont'd.)				
QTY.	UNIT	ITEM	UNIT COST	AMOUNT
	L.F.	60" C.S.P.	\$ 115.00	\$ -
	EA.	Catch Basin W = 4'	\$ 1,700.00	\$ -
	EA.	Catch Basin W = 7'	\$ 3,000.00	\$ -
	EA.	Catch Basin W = 10'	\$ 4,000.00	\$ -
	EA.	Catch Basin W = 14'	\$ 5,500.00	\$ -
	EA.	Catch Basin W = 21'	\$ 9,000.00	\$ -
	EA.	Type IX Inlet	\$ 2,500.00	\$ -
	EA.	Type X Inlet	\$ 2,500.00	\$ -
	EA.	Junction Structure No. 1	\$ 3,000.00	\$ -
	EA.	Junction Structure No. 2	\$ 2,500.00	\$ -
	EA.	Junction Structure No. 6	\$ 3,700.00	\$ -
	EA.	Transition Structure No. 1	\$ 2,000.00	\$ -
	EA.	Transition Structure No. 3	\$ 2,700.00	\$ -
	EA.	Manhole No. 1	\$ 2,700.00	\$ -
	EA.	Manhole No. 2	\$ 3,300.00	\$ -
	EA.	Manhole No. 3	\$ 2,700.00	\$ -
	EA.	Manhole No. 4	\$ 5,000.00	\$ -
	EA.	Adjust Water Valve (if no water plan)	\$ 150.00	\$ -
	EA.	Adjust MH to grade (if no sewer plan)	\$ 400.00	\$ -
	EA.	Headwall	\$ 5,000.00	\$ -
	L.S.	Remove & Dispose of Interfering 30" Storm Drain and 36" Riser	\$ 500.00	\$ -
	EA.	Remove & Dispose of RCB Headwall & Wingwall	\$ 10,000.00	\$ -
	L.F.	Concrete Bulkhead	\$ 25.00	\$ -
	EA.	Outlet Structure (Line A & B)	\$ 5,000.00	\$ -
	EA.	Remove Existing Headwall	\$ 1,000.00	\$ -
	EA.	Local Depression per RCTD Std 311 Case B	\$ 1,200.00	\$ -
	EA.	Local Depression per RCTD Std 311 Case C	\$ 1,500.00	\$ -
				\$ -
				\$ -
				\$ -

CITY OF BEAUMONT PUBLIC WORKS DEPARTMENT
IMPROVEMENT REQUIREMENT WORKSHEET

PROJECT: TRACT 31462-27 Sewer

DATE: 11-Jun-24

STREET IMPROVEMENTS (Cont'd.)				
QTY.	UNIT	ITEM	UNIT COST	AMOUNT
	EA.	Water Quality Structure	\$ 2,500.00	\$ -
	LS	Concrete Inlet Apron	\$ 11,000.00	\$ -
	LS	Emergency Spillway	\$ 27,000.00	\$ -
	LS	84" Storm Drain Grate	\$ 8,500.00	\$ -
	SF	3' Wide V-Gutter	\$ 4.00	\$ -
	LS	Signal & Lighting	\$ 100,000.00	\$ -
				\$ -
				\$ -
				\$ -
				\$ -

Subtotal: \$ -

A. Subtotal \$ -

B. Contingency (15%) \$ -

C. Streets/Drainage Total (A + B) \$ -

CITY OF BEAUMONT PUBLIC WORKS DEPARTMENT
IMPROVEMENT REQUIREMENT WORKSHEET

PROJECT: TRACT 31462-27 Sewer

DATE: 11-Jun-24

SEWER IMPROVEMENTS

Show quantities on this sheet only if project has a sewer plan. If no water plan, then show applicable quantities as part of street improvements.

QTY.	UNIT	ITEM	UNIT COST	AMOUNT
	L.F.	4" P.V.C. (45 Lots @ 25' Avg. Length & 5' for cleanout)	\$ 15.00	\$ -
1,626	L.F.	4" P.V.C. Force Main & Fittings	\$ 26.00	\$ 42,276
1,958	L.F.	8" P.V.C. Sewer Main Pipe	\$ 50.00	\$ 97,900
	L.F.	12" P.V.C Sewer Main Pipe	\$ 70.00	
	L.F.	8" V.C.P.	\$ 30.00	\$ -
	L.F.	10" V.C.P.	\$ 35.00	\$ -
	L.F.	12" V.C.P.	\$ 40.00	\$ -
	L.F.	15" V.C.P.	\$ 50.00	\$ -
4	EA.	Standard or Terminus Manholes	\$ 2,500.00	\$ 10,000
7	EA.	48" Manhole	\$ 3,000.00	\$ 21,000
	EA.	60" Manhole	\$ 3,500.00	\$ -
	EA.	Drop Manholes	\$ 4,000.00	\$ -
59	EA.	Cleanouts	\$ 500.00	\$ 29,500
	EA.	Sewer Y's	\$ 25.00	\$ -
	EA.	Chimneys	\$ 400.00	\$ -
	EA.	Adjust M.H. to grade	\$ 500.00	\$ -
	L.F.	Concrete Encasement	\$ 35.00	\$ -
	EA.	4" P.V.C. Misc. Fittings	\$ 120.00	\$ -
	L.F.	Sewer Pipe Sleeving	\$ 36.00	\$ -
	EA.	Sauereisen Coating	\$ 3,000.00	\$ -
22	EA.	Backflow prevention device	\$ 250.00	\$ 5,500
	C.Y.	Controlled Density Fill	\$ 4.00	\$ -
	EA.	8" End Caps	\$ 100.00	\$ -
1	EA.	Remove 8" End Cap and Join	\$ 110.00	\$ 110
	EA.	Remove 12" End Cap and Join	\$ 130.00	\$ -

A.	Subtotal	\$ 206,286
B.	Contingency (15% x A)	\$ 30,943
C.	Sewer Total (A + B)	\$ 237,229

Bond No: 024279664

PW #: 2024-0036
File #: 3506

PERFORMANCE BOND

Exhibit "C"

WHEREAS, the City Council of the City of Beaumont, State of California, and Meritage Homes of California, Inc. (hereinafter designated as "Principal") have entered into Agreement To Provide Security For Improvements For Tract Map Or Parcel Map Or Plot Plan, dated, June 11, 2024, whereby Principal agrees to install and complete certain designated public improvements itemized and described on Tract Map, Parcel Map or Plot Plan No. 31462-27, which is hereby incorporated herein and made a part hereof; and

WHEREAS, Principal is required under the terms of the said agreement to furnish a bond for the faithful performance of said agreement.

NOW, THEREFORE, we, the Principal and Liberty Mutual Insurance Company, as Surety, are held and firmly bound unto the City of Beaumont (hereinafter called "City"), in the penal sum of Two Hundred Thirty Seven Thousand Two Hundred Twenty Eight and 90/100 dollars (\$237,228.90) lawful money of the United States, for the payment of which sum well and truly to be made, we bind ourselves, our heirs, successors, executors and administrators, jointly and severally, firmly by these presents.

The condition of this obligation is such that if the above bounded Principal, his or its heirs, executors, administrators, successors or assigns, shall in all things stand to and abide by, and well and truly keep and perform the covenants, conditions and provisions in the said agreement and any alteration thereof made as therein provided, on his or their part to be kept and performed at the time and in the manner therein specified, and in all respects according to their true intent and meaning, and shall indemnify and save harmless the City, its officers, agents and employees as therein stipulated, then this obligation shall become null and void; otherwise it shall be and remain in full force and effect.

As part of the obligation secured hereby and in addition to the face amount specified therefor, there shall be included costs and reasonable expenses and fees, including reasonable attorney's fees, incurred by the City in successfully enforcing such obligation, all to be taxed as costs and included in any judgment therein rendered.

The Surety hereby stipulates and agrees that no change, extension of time, alteration or addition to the terms of the agreement or to the work to be performed thereunder or the specifications accompanying the same shall in any way affect its obligations on this bond, and it does hereby waive notice of any such change, extension of time, alteration or addition to the terms of the agreement or to the work or to the specifications.

[signatures on following page]

IN WITNESS WHEREOF, this instrument has been duly executed by the Principal and Surety above named, on the 20th day of August, 2024.

(Seal)

(Seal)

Liberty Mutual Insurance Company

Meritage Homes of California, Inc.

SURETY

PRINCIPAL

By: 

By: 

Name: Brenda Wong

Name: Hilla Sferruzza

Title: Attorney-in-Fact

Title: EVP- CFO

Address: 633 W. 5th Street, Suite 1200

By: 

Los Angeles, CA 90071

Name: Glen TUIK

Title: SVP- National Land Development

Address: 18655 North claret Drive,

suite 400, Scottsdale, AZ 85255

ALL SIGNATURES MUST BE ACKNOWLEDGED BEFORE A NOTARY PUBLIC

ALL-PURPOSE ACKNOWLEDGEMENT

A notary public or other officer completing this certificate verifies only the identity of the individual who signed the document to which this certificate is attached, and not the truthfulness, accuracy, or validity of that document.

STATE OF ARIZONA)SS
COUNTY OF MARICOPA)

On August 28, 2024 before me, Jeanne A. Malys, Notary Public, personally appeared

Hilla Sferruzza, Executive Vice President - Chief Financial Officer, Meritage Homes of California, Inc.
who proved to me on the basis of satisfactory evidence to be the person(s) whose name(s) is/are subscribed to the within instrument and acknowledged to me that he/she/they executed the same in his/her/their authorized capacity(ies), and that by his/her/their signature(s) on the instrument the person(s), or the entity upon behalf of which the person(s) acted, executed the instrument.

I certify under PENALTY OF PERJURY under the laws of the State of Arizona that the foregoing paragraph is true and correct.

WITNESS my hand and official seal.

Signature Jeanne A Malys

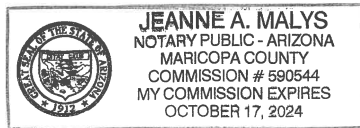

This area for official notarial seal.

OPTIONAL SECTION - NOT PART OF NOTARY ACKNOWLEDGEMENT CAPACITY CLAIMED BY SIGNER

Though statute does not require the Notary to fill in the data below, doing so may prove invaluable to persons relying on the documents.

- INDIVIDUAL
- CORPORATE OFFICER(S) TITLE(S)
- PARTNER(S) LIMITED GENERAL
- ATTORNEY-IN-FACT
- TRUSTEE(S)
- GUARDIAN/CONSERVATOR
- OTHER

SIGNER IS REPRESENTING:

Name of Person or Entity _____

Name of Person or Entity _____

OPTIONAL SECTION - NOT PART OF NOTARY ACKNOWLEDGEMENT

Though the data requested here is not required by law, it could prevent fraudulent reattachment of this form.

THIS CERTIFICATE MUST BE ATTACHED TO THE DOCUMENT DESCRIBED BELOW

TITLE OR TYPE OF DOCUMENT: _____

NUMBER OF PAGES _____ DATE OF DOCUMENT _____

SIGNER(S) OTHER THAN NAMED ABOVE _____

ALL-PURPOSE ACKNOWLEDGEMENT

A notary public or other officer completing this certificate verifies only the identity of the individual who signed the document to which this certificate is attached, and not the truthfulness, accuracy, or validity of that document.

STATE OF ARIZONA)SS
COUNTY OF MARICOPA)

On August 28, 2024 before me, Jeanne A. Malys, Notary Public, personally appeared Glen Tulk, Sr Vice President - Nat'l Land Development of Meritage Homes of California, Inc., a California corporation who proved to me on the basis of satisfactory evidence to be the person(s) whose name(s) is/are subscribed to the within instrument and acknowledged to me that he/she/they executed the same in his/her/their authorized capacity(ies), and that by his/her/their signature(s) on the instrument the person(s), or the entity upon behalf of which the person(s) acted, executed the instrument.

I certify under PENALTY OF PERJURY under the laws of the State of Arizona that the foregoing paragraph is true and correct.

WITNESS my hand and official seal.

Signature Jeanne A. Malys

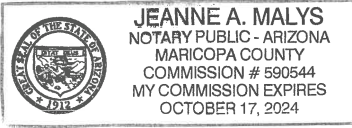

This area for official notarial seal.

**OPTIONAL SECTION - NOT PART OF NOTARY ACKNOWLEDGEMENT
CAPACITY CLAIMED BY SIGNER**

Though statute does not require the Notary to fill in the data below, doing so may prove invaluable to persons relying on the documents.

- INDIVIDUAL
- CORPORATE OFFICER(S) TITLE(S)
- PARTNER(S) LIMITED GENERAL
- ATTORNEY-IN-FACT
- TRUSTEE(S)
- GUARDIAN/CONSERVATOR
- OTHER

SIGNER IS REPRESENTING:

Name of Person or Entity _____ Name of Person or Entity _____

OPTIONAL SECTION - NOT PART OF NOTARY ACKNOWLEDGEMENT

Though the data requested here is not required by law, it could prevent fraudulent reattachment of this form.

THIS CERTIFICATE MUST BE ATTACHED TO THE DOCUMENT DESCRIBED BELOW

TITLE OR TYPE OF DOCUMENT: _____
NUMBER OF PAGES _____ DATE OF DOCUMENT _____
SIGNER(S) OTHER THAN NAMED ABOVE _____

**CALIFORNIA ALL-PURPOSE ACKNOWLEDGMENT
CIVIL CODE §1189**

A notary public or other officer completing this certificate verifies only the identity of the individual who signed the document to which this certificate is attached, and not the truthfulness, accuracy, or validity of that document.

State of California

County of Los Angeles

On 8/20/2024 before me, M.Gonzales, Notary Public, personally appeared Brenda Wong who proved to me on the basis of satisfactory evidence to be the person(s) whose name(s) is/are subscribed to the within instrument and acknowledged to me that he/she/they executed the same in his/her/their authorized capacity(ies), and that by his/her/their signature(s) on the instrument the person(s), or the entity upon behalf of which the person(s) acted, executed the instrument.

I certify under PENALTY OF PERJURY under the laws of the State of California that the foregoing paragraph is true and correct.

WITNESS my hand and official seal.

(seal)

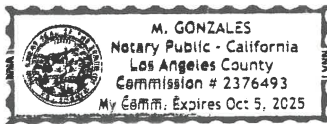

Signature M. Gonzales
M.Gonzales, Notary Public



This Power of Attorney limits the acts of those named herein, and they have no authority to bind the Company except in the manner and to the extent herein stated.

Liberty Mutual Insurance Company
The Ohio Casualty Insurance Company
West American Insurance Company

Certificate No: 8204866

POWER OF ATTORNEY

KNOWN ALL PERSONS BY THESE PRESENTS: That The Ohio Casualty Insurance Company is a corporation duly organized under the laws of the State of New Hampshire, that Liberty Mutual Insurance Company is a corporation duly organized under the laws of the State of Massachusetts, and West American Insurance Company is a corporation duly organized under the laws of the State of Indiana (herein collectively called the "Companies"), pursuant to and by authority herein set forth, does hereby name, constitute and appoint,

Brenda Wong

all of the city of Los Angeles, state of California each individually if there be more than one named, its true and lawful attorney-in-fact to make, execute, seal, acknowledge and deliver, for and on its behalf as surety and as its act and deed, any and all undertakings, bonds, recognizances and other surety obligations, in pursuance of these presents and shall be as binding upon the Companies as if they have been duly signed by the president and attested by the secretary of the Companies in their own proper persons.

IN WITNESS WHEREOF, this Power of Attorney has been subscribed by an authorized officer or official of the Companies and the corporate seals of the Companies have been affixed thereto this 1st day of July, 2024.

Liberty Mutual Insurance Company
The Ohio Casualty Insurance Company
West American Insurance Company



By: [Signature]

Nathan J. Zangerle, Assistant Secretary

STATE OF PENNSYLVANIA ss
COUNTY OF MONTGOMERY

On this 1st day of July, 2024, before me personally appeared Nathan J. Zangerle, who acknowledged himself to be the Assistant Secretary of Liberty Mutual Insurance Company, The Ohio Casualty Company, and West American Insurance Company, and that he, as such, being authorized so to do, execute the foregoing instrument for the purposes therein contained by signing on behalf of the corporations by himself as a duly authorized officer.

IN WITNESS WHEREOF, I have hereunto subscribed my name and affixed my notarial seal at Plymouth Meeting, Pennsylvania, on the day and year first above written.



Commonwealth of Pennsylvania - Notary Seal
Teresa Pastella, Notary Public
Montgomery County
My commission expires March 28, 2025
Commission number 1126044
Member, Pennsylvania Association of Notaries

By: [Signature]

Teresa Pastella, Notary Public

This Power of Attorney is made and executed pursuant to and by authority of the following By-laws and Authorizations of The Ohio Casualty Insurance Company, Liberty Mutual Insurance Company, and West American Insurance Company which resolutions are now in full force and effect reading as follows:

ARTICLE IV - OFFICERS: Section 12. Power of Attorney.

Any officer or other official of the Corporation authorized for that purpose in writing by the Chairman or the President, and subject to such limitation as the Chairman or the President may prescribe, shall appoint such attorneys-in-fact, as may be necessary to act in behalf of the Corporation to make, execute, seal, acknowledge and deliver as surety any and all undertakings, bonds, recognizances and other surety obligations. Such attorneys-in-fact, subject to the limitations set forth in their respective powers of attorney, shall have full power to bind the Corporation by their signature and execution of any such instruments and to attach thereto the seal of the Corporation. When so executed, such instruments shall be as binding as if signed by the President and attested to by the Secretary. Any power or authority granted to any representative or attorney-in-fact under the provisions of this article may be revoked at any time by the Board, the Chairman, the President or by the officer or officers granting such power or authority.

ARTICLE XIII - Execution of Contracts: Section 5. Surety Bonds and Undertakings.

Any officer of the Company authorized for that purpose in writing by the chairman or the president, and subject to such limitations as the chairman or the president may prescribe, shall appoint such attorneys-in-fact, as may be necessary to act in behalf of the Company to make, execute, seal, acknowledge and deliver as surety any and all undertakings, bonds, recognizances and other surety obligations. Such attorneys-in-fact, subject to the limitations set forth in their respective powers of attorney, shall have full power to bind the Company by their signature and execution of any such instruments and to attach thereto the seal of the Company. When so executed such instruments shall be as binding as if signed by the president and attested by the secretary.

Certificate of Designation - The President of the Company, acting pursuant to the Bylaws of the Company, authorizes Nathan J. Zangerle, Assistant Secretary to appoint such attorneys-in-fact as may be necessary to act on behalf of the Company to make, execute, seal, acknowledge and deliver as surety any and all undertakings, bonds, recognizances and other surety obligations.

Authorization - By unanimous consent of the Company's Board of Directors, the Company consents that facsimile or mechanically reproduced signature of any assistant secretary of the Company, wherever appearing upon a certified copy of any power of attorney issued by the Company in connection with surety bonds, shall be valid and binding upon the Company with the same force and effect as though manually affixed.

I, Renee C. Llewellyn, the undersigned, Assistant Secretary, of Liberty Mutual Insurance Company, The Ohio Casualty Insurance Company, and West American Insurance Company do hereby certify that this power of attorney executed by said Companies is in full force and effect and has not been revoked.

IN TESTIMONY WHEREOF, I have hereunto set my hand and affixed the seals of said Companies this 20th day of August, 2024.



By: [Signature]

Renee C. Llewellyn, Assistant Secretary

Not valid for mortgage, note, loan, letter of credit, currency rate, interest rate or residual value guarantees.

For bond and/or Power of Attorney (POA) verification inquiries, please call 610-832-8240 or email HOSUR@libertymutual.com.

Bond No: 024279664

PAYMENT BOND

WHEREAS, the City Council of the City of Beaumont, State of California, and Meritage Homes of California, Inc. (hereafter designated as “the Principal”) have entered into Agreement To Provide Security For Improvements For Tract Map Or Parcel Map Or Plot Plan, dated June 11, 2024, whereby Principal agrees to install and complete certain designated public improvements which is hereby incorporated herein and made a part hereof; and

WHEREAS, under the terms of the said agreement, the Principal is required before entering upon the performance of the work, to file a good and sufficient payment bond with the City of Beaumont to secure the claims to which reference is made in Title 3 (commencing with Section 9000, et seq.) of Part 6 of Division 4 of the Civil Code of the State of California.

NOW, THEREFORE, the Principal and the undersigned as corporate surety, are held firmly bound unto the City of Beaumont and all contractors, subcontractors, laborers, materialmen, and other persons employed in the performance of the said agreement and referred to at Title 3 (commencing with Section 9000, et seq.) of Part 6 of Division 4 of the Civil Code in the sum of Two Hundred Thirty Seven Thousand Two Hundred Twenty Eight and 90/100 dollars (\$ 237,228.90), for materials furnished or labor thereon of any kind, or for amounts due under the Unemployment Insurance Act with respect to this work or labor, that the Surety will pay the same in an amount not exceeding the amount hereinabove set forth, and also in case suit is brought upon this bond, will pay, in addition to the face amount thereof, costs and reasonable expenses and fees, including reasonable attorney’s fees, incurred by the City in successfully enforcing this obligation, to be awarded and fixed by the court, and to be taxed as costs and to be included in the judgment therein rendered.

It is hereby expressly stipulated and agreed that this bond shall inure to the benefit of any and all persons, companies, and corporations entitled to file claims under Title 3 (commencing with Section 9000, et seq.) of Part 6 of Division 4 of the Civil Code, so as to give a right of action to them or their assigns in any suit brought upon this bond.

Should the condition of this bond be fully performed, then this obligation shall become null and void, otherwise it shall be and remain in full force and effect.

The Surety hereby stipulates and agrees that no change, extension of time, alteration, or addition to the terms of the agreement or the specifications accompanying the same shall in any manner affect its obligations on this bond, and it does hereby waive notice of any such change, extension, alteration, or addition.

[signatures on following page]

IN WITNESS WHEREOF, this instrument has been duly executed by the Principal and Surety above named, on the 2nd day of October, 2024.

(Seal)

(Seal)

Liberty Mutual Insurance Company

SURETY

By: _____

Brenda Wong

Name: _____

Attorney-in-Fact

Title: _____

Address: 633 W. 5th Street, Suite 1200

Los Angeles, CA 90071

Meritage Homes of California Inc.

PRINCIPAL

By: _____

Name: Glen Tulk

Title: SVP-National Land Development

By: _____

Name: Alison Sasser

Title: SVP-Chief Accounting Officer

Address: 18655 North Claret Drive, Suite 400

Scottsdale, AZ 85255

ALL SIGNATURES MUST BE ACKNOWLEDGED BEFORE A NOTARY PUBLIC

ALL-PURPOSE NOTARY ACKNOWLEDGEMENT

A notary public or other officer completing this certificate verified only the identity of the individual who signed the document to which this certificate is attached, and not the truthfulness, accuracy, or validity of that

State of Arizona)
County of Maricopa) ss
)

On Oct 11 2024 before me, Deborah Warner-Rapier, Notary Public, personally appeared Glen A. Tulk, VP -National Land of Meritage Homes of California, Inc, who proved to me on the basis of satisfactory evidence to be the person whose name is subscribed to the within instrument and acknowledged to me that he executed the same in his authorized capacity, and that his signature on the instrument the person(s), or entity upon which the person(s) acted, executed the instrument.

I certify under PENALTY OF PERJERY under the laws of the State of Arizona that the foregoing paragraph is true and correct.

WITNESS my hand and official seal.

Signature: *Deborah Warner-Rapier*

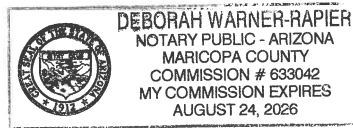

Official Notarial Seal/Stamp

OPTIONAL SECTION – NOT PART OF NOTARY ACKNOWLEDGMENT CAPACITY CLAIMED BY SIGNER

Though statute does not require the Notary to complete the data below, doing so may prove invaluable to persons relying on the documents.

- Individual
- Corporate Officer(s) Title(s)
- Partner(s) Limited General
- Attorney-in-Fact
- Guardian/Conservator
- Other

SIGNER IS REPRESENTING: _____
Name of Person or Entity Name of Person or Entity

OPTIONAL SECTION – NOT PART OF NOTARY

Though the data requested here is not required by law, it could prevent fraudulent reattachment of this form.

OPTIONAL SECTION – NOT PART OF NOTARY

TITLE OF TYPE OF DOCUMENT: _____

NUMBER OF PAGES: _____ DATE OF DOCUMENT: _____

SIGNER(S) OTHER THAN NAMED ABOVE: _____

ALL-PURPOSE NOTARY ACKNOWLEDGEMENT

A notary public or other officer completing this certificate verified only the identity of the individual who signed the document to which this certificate is attached, and not the truthfulness, accuracy, or validity of that

State of Arizona)
County of Maricopa) ss

On Oct 11 2024, before me, Deborah Warner-Rapier, Notary Public, personally appeared Alison Sasser, SVP-Chief Accounting Officer of Meritage Homes Corporation, who proved to me on the basis of satisfactory evidence to be the person whose name is subscribed to the within instrument and acknowledged to me that she executed the same in her authorized capacity, and that her signature on the instrument the person(s), or entity upon which the person(s) acted, executed the instrument.

I certify under PENALTY OF PERJURY under the laws of the State of Arizona that the foregoing paragraph is true and correct.

WITNESS my hand and official seal.

Signature: _____

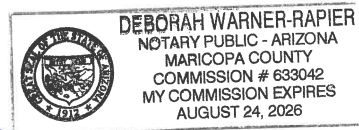
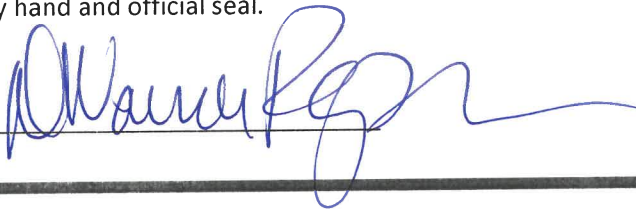

Official Notarial Seal/Stamp

OPTIONAL SECTION – NOT PART OF NOTARY ACKNOWLEDGMENT CAPACITY CLAIMED BY SIGNER

Though statute does not require the Notary to complete the data below, doing so may prove invaluable to persons relying on the documents.

- Individual
- Corporate Officer(s) Title(s)
- Partner(s) Limited General
- Attorney-in-Fact
- Guardian/Conservator
- Other

SIGNER IS REPRESENTING: _____
Name of Person or Entity Name of Person or Entity

OPTIONAL SECTION – NOT PART OF NOTARY

Though the data requested here is not required by law, it could prevent fraudulent reattachment of this form.

OPTIONAL SECTION – NOT PART OF NOTARY

TITLE OF TYPE OF DOCUMENT: _____

NUMBER OF PAGES: _____ DATE OF DOCUMENT: _____

SIGNER(S) OTHER THAN NAMED ABOVE: _____

**CALIFORNIA ALL-PURPOSE ACKNOWLEDGMENT
CIVIL CODE §1189**

A notary public or other officer completing this certificate verifies only the identity of the individual who signed the document to which this certificate is attached, and not the truthfulness, accuracy, or validity of that document.

State of California

County of Los Angeles

On 10/2/2024 before me, M. Gonzales, Notary Public, personally appeared Brenda Wong who proved to me on the basis of satisfactory evidence to be the person(s) whose name(s) is/are subscribed to the within instrument and acknowledged to me that he/she/they executed the same in his/her/their authorized capacity(ies), and that by his/her/their signature(s) on the instrument the person(s), or the entity upon behalf of which the person(s) acted, executed the instrument.

I certify under PENALTY OF PERJURY under the laws of the State of California that the foregoing paragraph is true and correct.

WITNESS my hand and official seal.

(seal)

Signature M. Gonzales
M. Gonzales, Notary Public

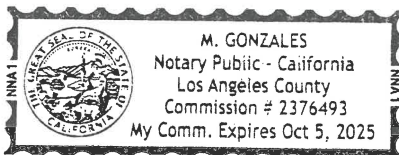



POWER OF ATTORNEY

Certificate No: 8204866

Liberty Mutual Insurance Company
The Ohio Casualty Insurance Company
West American Insurance Company

KNOWN ALL PERSONS BY THESE PRESENTS: That The Ohio Casualty Insurance Company is a corporation duly organized under the laws of the State of New Hampshire, that Liberty Mutual Insurance Company is a corporation duly organized under the laws of the State of Massachusetts, and West American Insurance Company is a corporation duly organized under the laws of the State of Indiana (herein collectively called the "Companies"), pursuant to and by authority herein set forth, does hereby name, constitute and appoint,

Brenda Wong all of the city of

Los Angeles, state of California each individually if there be more than one named, its true and lawful attorney-in-fact to make, execute, seal, acknowledge and deliver, for and on its behalf as surety and as its act and deed, any and all undertakings, bonds, recognizances and other surety obligations, in pursuance of these presents and shall be as binding upon the Companies as if they have been duly signed by the president and attested by the secretary of the Companies in their own proper persons.

IN WITNESS WHEREOF, this Power of Attorney has been subscribed by an authorized officer or official of the Companies and the corporate seals of the Companies have been affixed thereto this 1st day of July, 2024.

Liberty Mutual Insurance Company
The Ohio Casualty Insurance Company
West American Insurance Company



By:

Nathan J. Zangerle, Assistant Secretary

STATE OF PENNSYLVANIA ss
COUNTY OF MONTGOMERY

On this 1st day of July, 2024, before me personally appeared Nathan J. Zangerle, who acknowledged himself to be the Assistant Secretary of Liberty Mutual Insurance Company, The Ohio Casualty Company, and West American Insurance Company, and that he, as such, being authorized so to do, execute the foregoing instrument for the purposes therein contained by signing on behalf of the corporations by himself as a duly authorized officer.

IN WITNESS WHEREOF, I have hereunto subscribed my name and affixed my notarial seal at Plymouth Meeting, Pennsylvania, on the day and year first above written.



Commonwealth of Pennsylvania - Notary Seal
Teresa Pastella, Notary Public
Montgomery County
My commission expires March 28, 2025
Commission number 1126044
Member, Pennsylvania Association of Notaries

By:

Teresa Pastella, Notary Public

This Power of Attorney is made and executed pursuant to and by authority of the following By-laws and Authorizations of The Ohio Casualty Insurance Company, Liberty Mutual Insurance Company, and West American Insurance Company which resolutions are now in full force and effect reading as follows:

ARTICLE IV – OFFICERS: Section 12. Power of Attorney.

Any officer or other official of the Corporation authorized for that purpose in writing by the Chairman or the President, and subject to such limitation as the Chairman or the President may prescribe, shall appoint such attorneys-in-fact, as may be necessary to act in behalf of the Corporation to make, execute, seal, acknowledge and deliver as surety any and all undertakings, bonds, recognizances and other surety obligations. Such attorneys-in-fact, subject to the limitations set forth in their respective powers of attorney, shall have full power to bind the Corporation by their signature and execution of any such instruments and to attach thereto the seal of the Corporation. When so executed, such instruments shall be as binding as if signed by the President and attested to by the Secretary. Any power or authority granted to any representative or attorney-in-fact under the provisions of this article may be revoked at any time by the Board, the Chairman, the President or by the officer or officers granting such power or authority.

ARTICLE XIII - Execution of Contracts: Section 5. Surety Bonds and Undertakings.

Any officer of the Company authorized for that purpose in writing by the chairman or the president, and subject to such limitations as the chairman or the president may prescribe, shall appoint such attorneys-in-fact, as may be necessary to act in behalf of the Company to make, execute, seal, acknowledge and deliver as surety any and all undertakings, bonds, recognizances and other surety obligations. Such attorneys-in-fact, subject to the limitations set forth in their respective powers of attorney, shall have full power to bind the Company by their signature and execution of any such instruments and to attach thereto the seal of the Company. When so executed such instruments shall be as binding as if signed by the president and attested by the secretary.

Certificate of Designation – The President of the Company, acting pursuant to the Bylaws of the Company, authorizes Nathan J. Zangerle, Assistant Secretary to appoint such attorneys-in-fact as may be necessary to act on behalf of the Company to make, execute, seal, acknowledge and deliver as surety any and all undertakings, bonds, recognizances and other surety obligations.

Authorization – By unanimous consent of the Company's Board of Directors, the Company consents that facsimile or mechanically reproduced signature of any assistant secretary of the Company, wherever appearing upon a certified copy of any power of attorney issued by the Company in connection with surety bonds, shall be valid and binding upon the Company with the same force and effect as though manually affixed.

I, Renee C. Llewellyn, the undersigned, Assistant Secretary, of Liberty Mutual Insurance Company, The Ohio Casualty Insurance Company, and West American Insurance Company do hereby certify that this power of attorney executed by said Companies is in full force and effect and has not been revoked.

IN TESTIMONY WHEREOF, I have hereunto set my hand and affixed the seals of said Companies this 2nd day of October, 2024.



By:

Renee C. Llewellyn, Assistant Secretary

Not valid for mortgage, note, loan, letter of credit, currency rate, interest rate or residual value guarantees.

For bond and/or Power of Attorney (POA) verification inquiries, please call 610-832-8240 or email HOSUR@libertymutual.com.

SEWER NOTES

- SEWER CONSTRUCTION AND MATERIALS SHALL BE IN ACCORDANCE WITH THE CITY OF BEAUMONT'S STANDARDS AND SPECIFICATIONS AND EASTERN MUNICIPAL WATER DISTRICT'S (EMWD) GUIDELINE.
- GRAVITY SEWER PROFILE ELEVATIONS ARE TO BE FLOW LINES (CONDUIT INVERTS).
- MANHOLES SHALL BE CONSTRUCTED IN ACCORDANCE WITH EMWD STD. 53. SEWER MAINS MAY BE LAID THROUGH THE MANHOLES AND USED AS A FORM FOR THE INVERT. CAST IRON SHALL BE USED FOR MANHOLE COVERS AND SHALL HAVE A 12" COVERING RING.
- PRIOR TO CONSTRUCTION OF SEWER, CONTRACTOR SHALL EXPOSE EXISTING SEWER AND VERIFY ITS EXISTING ELEVATION. WHERE CONNECTION TO EXISTING MANHOLES AND INLET STUB OF PROPER SIZE EXISTS, NO ALTERATIONS SHALL BE MADE TO EXISTING MANHOLE BASE OR STUB EXCEPT AS SPECIFICALLY AUTHORIZED BY THE CITY OF BEAUMONT.
- WHERE A NEW INLET MUST BE CONSTRUCTED IN AN EXISTING MANHOLE, THE ELEVATION OF THE INLET SHALL BE SUCH THAT ITS CROWN SHALL BE LEVELED WITH THE CROWN OF THE OUTLET PIPE, AT THEIR PROJECTIONS TO THE MANHOLE CENTERLINE.
- ALL SEWER INLETS AT THE MANHOLE SHALL BE SUCH THAT ITS CROWN SHALL BE LEVEL WITH THE CROWN OF THE OUTLET PIPE, AT THEIR PROJECTION TO THE MANHOLE CENTERLINE.
- THE CONTRACTOR IS ADVISED THAT THE WORK ON THIS PROJECT MAY INVOLVE WORKING IN A CONFINED AIR SPACE. CONTRACTOR SHALL BE RESPONSIBLE FOR "CONFINED AIR SPACE" ARTICLE 108, TITLE 8 CALIFORNIA ADMINISTRATION CODE.
- PROVIDE BACKFLOW PREVENTION DEVICES WHERE UPSTREAM MANHOLE RIM IS HIGHER THAN PAD ELEVATION.
- PROVIDE APPROPRIATE MARKING TAPE AT TOP OF THE PIPE CENTERLINE ON TOP OF PIPE BEDDING.
- SEWER LATERAL SHALL BE TYPE "A" PER DETAIL SHOWN HEREON, UNLESS OTHERWISE NOTED OR DETAILED ON PLAN.
- DEVELOPER SHALL HAVE GEOTECHNICAL/ SOIL ENGINEERING FIRM OBSERVE TRENCHING, BACKFILLING AND SOIL COMPACTION OF ALL UTILITY TRENCHES WITHIN EASEMENTS AND ROAD RIGHT OF WAY. TWO SETS OF COMPACTION REPORTS CERTIFYING THAT WORK WAS DONE IN CONFORMANCE TO STANDARDS AND GEOTECHNICAL REPORT SHALL BE SUBMITTED TO THE DEPARTMENT OF PUBLIC WORKS AT LEAST TWO WORKING DAYS BEFORE AGGREGATE BASE MATERIALS ARE PLACED ONSITE.
- UTILITY TRENCH BACKFILL PER PLAN, PROFILE, EMWD STD. SB-158 AND LATEST GREEN BOOK SECTION 306. CRUSH ROCK BEDDING, HAUNCHING, INITIAL BACKFILL PER GREEN BOOK TABLE 306.-1.2.13(B), MAXIMUM ROCK GRADATION 1/2 INCH FOR PVC PIPE SIZE 15 INCH AND SMALLER AND 3/4 INCH CRUSH ROCK FOR PVC PIPE LARGER THAN 15 INCHES DIAMETER.
- TRENCHING AND EXCAVATION PER 29 CFR 1926.651 AND 1926.652 OR COMPARABLE OSHA-APPROVED STATE PLAN REQUIREMENT.
- SEWER MAINS 15 INCH IN DIAMETER AND SMALLER AT DEPTHS BETWEEN 15 AND 20 FEET (FROM FINISH SURFACE TO THE TOP OF THE PIPE) HIGHER CLASS OF BEDDING OR STRONGER PIPE OR BOTH CAN BE USED, OTHERWISE PROVIDE A SOILS REPORT/ SUPPORTING CALCULATIONS TO SUBSTANTIATE THE USE OF PVC SDR 35 SEWER PIPE.
- MAX VELOCITY OF THE SEWER MAIN SHALL NOT EXCEED 10FT/SEC DESIGN FLOW AND MINIMUM ACCEPTED VELOCITY SHALL BE 2FT/SEC DESIGN FLOW (MAX DEPTHS: 1/2 FULL FOR 12" DIAMETER AND SMALLER AND 3/4 FULL FOR 15" AND LARGER DIAMETER). MAXIMUM SLOPES ARE AS FOLLOWS: 8"-0.1200, 10"-0.085, 12"-0.0660, 15"-0.0500, 18"-0.3700, 21"-0.0300, 24"-0.0250. MINIMUM SLOPES ARE AS FOLLOWS: LATERALS: 4 & 6 INCHES- 0.020, MAIN LINES SHALL BE 0.006 PER CITY OF BEAUMONT MUNICIPAL CODE SECTION 13.08.550.
- VERTICAL AND HORIZONTAL SEPARATION OF LATERALS OR SEWER MAIN FROM WATER OR RECYCLE WATER LINE SHALL BE IN ACCORDANCE WITH SWRCB-DDW.
- WHEN SEWER LINE CROSS OTHER UTILITIES, STORM DRAINS, OR OTHER OBSTRUCTIONS, THE OUTSIDE PIPE ELEVATIONS SHOULD BE SHOWN TO INDICATE THE AVAILABLE CLEARANCES.
- MANHOLES OF DEPTH MORE THAN 12 FEET FROM FINISH STREET GRADE TO SEWER PIPE SHELF SHALL BE A MINIMUM 60" IN DIAMETER AND SHALL BE CONSTRUCTED PER EMWD STD. SB-53 AND PAVING AROUND MANHOLES SHALL BE CONSTRUCTED PER CITY OF BEAUMONT STANDARD SB-61M.
- MANHOLES OF DEPTH MORE THAN 12 FEET FROM FINISH STREET GRADE TO SEWER PIPE SHELF SHALL BE LINED WITH APPROVED CITY'S PVC LINER. THE BASE AND ALL REMAINING EXPOSED CONCRETE SHALL BE COATED WITH AN APPROVED POLYURETHANE COATING. THE LINING AND COATING SHALL BE FREE FROM DEFECTS, HOLES OR SURFACE IRREGULARITIES
- MANHOLE SPACING - THE MAXIMUM DISTANCE BETWEEN MANHOLES FOR PIPE 15 INCHES IN DIAMETER OR SMALLER IS 400 FEET, FOR 18 INCH DIAMETER AND OVER IS 500 FEET. MANHOLES ARE REQUIRED AT THE BEGINNING AND END OF THE CURVES. FOR RADII LESS THAN 500 FEET, THE MAXIMUM MANHOLE SPACING IS 200 FEET.
- MAINLINE AND LATERAL CLEANOUTS SHALL BE CONSTRUCTED IN ACCORDANCE WITH EMWD STD. SB-52. CLEANOUT PIPE MUST BE THE SAME DIAMETER AND MATERIAL AS MAIN SEWER LINE. CLEANOUT SHALL BE PLACED ON EACH LATERAL INSIDE OF THE PROPERTY LINE AND SHALL BE COORDINATED AND APPROVED BY BUILDING AND SAFETY DEPARTMENT.
- TESTING PIPELINES PER LATEST EDITION GREEN BOOK, SECTION 306-1.4.
- IN NO CASE SHALL THE SEWER SYSTEM BE ENTERED UNTIL ALL TESTING, CLEANING AND FINAL INSPECTION IS COMPLETED. NO FLUSHING WATER OR DEBRIS SHALL BE ALLOWED TO ENTER THE EXISTING SYSTEM.

GENERAL NOTES

- IT SHALL BE THE RESPONSIBILITY OF THE DEVELOPER/OWNER OR CONTRACTOR TO APPLY TO THE DIRECTOR OF PUBLIC WORKS, CITY OF BEAUMONT FOR AN ENCROACHMENT PERMIT FOR ALL WORK PERFORMED WITHIN PUBLIC RIGHT-OF-WAY.
- IT SHALL BE THE RESPONSIBILITY OF THE CONTRACTOR TO INSTALL AND MAINTAIN ALL CONSTRUCTION, REGULATORY, GUIDE AND WARNING SIGNS WITHIN THE PROJECT LIMITS AND ITS SURROUNDINGS AND TO PROVIDE SAFE PASSAGE FOR THE TRAVELING PUBLIC AND WORKERS UNTIL THE FINAL COMPLETION AND ACCEPTANCE.
- CONSTRUCTION PROJECTS THAT DISTURB MORE THAN ONE ACRE MUST OBTAIN A NATIONAL POLLUTANTS DISCHARGE ELIMINATION SYSTEM (NPDES) PERMIT. OWNER/DEVELOPERS ARE REQUIRED TO FILE A NOTICE OF INTENT (NOI) WITH THE STATE WATER RESOURCES CONTROL BOARD (SWRCB) AND COMPLY WITH ALL REQUIREMENTS OF THE BEAUMONT DRAINAGE MANAGEMENT PLAN.
- ALL WORK SHALL CONFORM TO THE LATEST EDITION OF COUNTY OF RIVERSIDE TRANSPORTATION DEPARTMENT (RCTD) ROAD IMPROVEMENT STANDARDS AND SPECIFICATIONS, COUNTY ORDINANCE 461 AND SUBSEQUENT AMENDMENTS.
- THE CONTRACTOR SHALL BE RESPONSIBLE FOR THE CLEARING OF THE PROPOSED WORK AREA AND RELOCATION COST OF ALL EXISTING UTILITIES. PERMITTEE MUST INFORM THE CITY OF CONSTRUCTION SCHEDULE AT LEAST 48 HOURS PRIOR TO BEGINNING OF CONSTRUCTION AT (951) 769-8520.
- ALL EXISTING SURVEY MONUMENTS SHALL BE PROTECTED IN PLACE OR RELOCATED BY A LICENSED PROFESSIONAL LAND SURVEYOR PRIOR TO CONSTRUCTION COMPLETION.
- TRENCHING FOR UTILITIES AND STRUCTURES IS NOT ALLOWED UNTIL SOIL COMPACTION REPORT IS SUBMITTED TO AND APPROVED BY THE PUBLIC WORKS DEPARTMENT. PRELIMINARY OR FINAL SOIL REPORT PROJECT NO. 1-0160-K, DATED APRIL 12, 2023, PREPARED BY ALTA CALIFORNIA GEOTECHNICAL INC. SHALL BE AVAILABLE UPON REQUEST.
- ALL UNDERGROUND FACILITIES WITH LATERALS, SHALL BE IN PLACE PRIOR TO PAVING THE STREET, INCLUDING, BUT NOT LIMITED TO, THE FOLLOWING, SEWER, WATER, GAS, ELECTRIC, STORM DRAINS, AND COMMUNICATION LINES.
- ALL MANHOLES, SURVEY MARKERS AND VALVES SHALL BE ADJUSTED TO GRADE BY THE CONTRACTOR AFTER COMPLETION OF THE OVERLAY.
- ASPHALTIC EMULSION (FOG SEAL) SHALL BE APPLIED NOT LESS THAN FOURTEEN DAYS FOLLOWING PLACEMENT OF THE ASPHALT SURFACING. SEAL AND PAINT BINDER SHALL BE APPLIED AT A RATE OF 0.05 AND 0.03 GALLON PER SQUARE YARD RESPECTIVELY. ASPHALTIC EMULSION SHALL CONFORM TO SECTION # 37, # 39, AND # 94 OF THE STATE STANDARD SPECIFICATIONS.
- DURING PAVING OPERATION, TRAFFIC CONTROL SHALL BE PERFORMED AS REQUIRED BY THE CITY ENGINEER.
- DEVELOPER SHALL BE FULLY RESPONSIBLE IN ASSURING THAT PROPOSED IMPROVEMENTS CONFORM TO THE APPROVED PLAN, SPECIFICATIONS AND THE CITY OF BEAUMONT STANDARDS, WHERE DEVIATION EXISTS, DEVELOPER SHALL PROPOSE CORRECTIVE MEASURES FOR REVIEW AND APPROVAL BY THE CITY.
- THE CONTRACTOR SHALL BEAR ALL COST FOR THE CORRECTION OR REMOVAL AND REPLACEMENT OF DEFECTIVE WORK, AND ALL ADDITIONAL DIRECT OR INDIRECT COSTS THE CITY MAY INCUR ON ACCOUNT OF DEFECTIVE WORK, INCLUDING THE COSTS OF ADDITIONAL ADMINISTRATIVE, PROFESSIONAL, CONSULTANT, INSPECTION, TESTING AND OTHER SERVICES.
- THE CITY RESERVES THE RIGHT TO REQUIRED REVISION OF THE APPROVED PLANS TO CONFORM WITH CURRENT STANDARDS AND TO POST A NEW BOND IF CONSTRUCTION HAS NOT COMMENCED WITHIN TWO YEARS AFTER PLANS WERE APPROVED.

SAUEREISEN COATING NOTES

EXISTING MANHOLE:
AS NOTED PER PLANS, MANHOLES SHALL BE COATED IN THE INTERIOR (SHAFT, CHANNEL, AND SHELVES) WITH 100% SOLID EPOXY POLYMER, SAUEREISEN SEWER GUARD GLAZE NO. 210GL OR APPROVED EQUAL. SURFACE PREPARATION INCLUDING SAUEREISEN UNDERLAYMENT NO. F-120 OR NO. 209 FILLER COMPOUND, ABRASIVE BLASTING, MIXING, APPLICATION, AND CURING SHALL BE AS RECOMMENDED BY MANUFACTURER. MINIMUM THICKNESS SHALL BE 20 MILS.

PROPOSED MANHOLE:
AS NOTED PER PLANS, MANHOLES SHALL BE COATED IN THE INTERIOR (SHAFT, CHANNEL, AND SHELVES) WITH 100% SOLID EPOXY POLYMER, SAUEREISEN SEWER GUARD GLAZE NO. 210GL OR APPROVED EQUAL. SURFACE PREPARATION INCLUDING SAUEREISEN UNDERLAYMENT NO. F-120 OR NO. 209 FILLER MINIMUM THICKNESS SHALL BE 20 MILS.

PRIVATE ENGINEERS NOTICE TO CONTRACTOR(S)

- THE EXISTENCE AND LOCATION OF ANY UNDERGROUND UTILITIES OR STRUCTURES SHOWN ON THESE PLANS ARE OBTAINED BY A SEARCH OF AVAILABLE RECORDS. TO THE BEST OF OUR KNOWLEDGE, THERE ARE NO EXISTING UTILITIES EXCEPT THOSE SHOWN ON THESE PLANS. THE CONTRACTOR IS REQUIRED TO TAKE ALL PRECAUTIONARY MEASURES TO PROTECT THE UTILITIES SHOWN, AND ANY OTHER LINES OR STRUCTURES NOT SHOWN ON THESE PLANS AND IS RESPONSIBLE FOR THE PROTECTION OF, AND ANY DAMAGE TO THESE LINES OR STRUCTURES
- IT SHALL BE THE CONTRACTOR'S RESPONSIBILITY TO NOTIFY THE OWNER OF ALL UTILITIES OR STRUCTURES CONCERNED BEFORE STARTING WORK.
- QUANTITIES SHOWN HEREON ARE PROVIDED FOR BIDDING PURPOSES ONLY. CONTRACTOR SHALL BE RESPONSIBLE FOR VERIFYING ALL QUANTITIES PRIOR TO BIDDING FOR CONSTRUCTION.
- THE PRIVATE ENGINEER SIGNING THESE PLANS IS RESPONSIBLE FOR ASSURING THE ACCURACY AND ACCEPTABILITY OF THE DESIGN HEREON. IN THE EVENT OF DISCREPANCIES ARISING AFTER CITY APPROVAL OR DURING CONSTRUCTION, THE PRIVATE ENGINEER SHALL BE RESPONSIBLE FOR DETERMINING AN ACCEPTABLE SOLUTION AND REVISING THE PLANS FOR APPROVAL BY THE CITY.

CITY OF BEAUMONT, CALIFORNIA SEWER IMPROVEMENT PLANS FOR TRACT 31462-27 FAIRWAY CANYON - 4C

BASIS OF TOPOGRAPHY

DIGITAL MAPPING, INC.
21062 BROOKHURST STREET, SUITE 101
HUNTINGTON BEACH, CA 92646
PHONE: (714) 968-5459
FAX: (714) 968-2429
EMAIL: ADMIN@ADMAP.COM

ASSESSOR'S PARCEL NO.

413-790-010

SITE ADDRESS

NORTH OF SORENSTAM DR.
CITY OF BEAUMONT, CA 92223

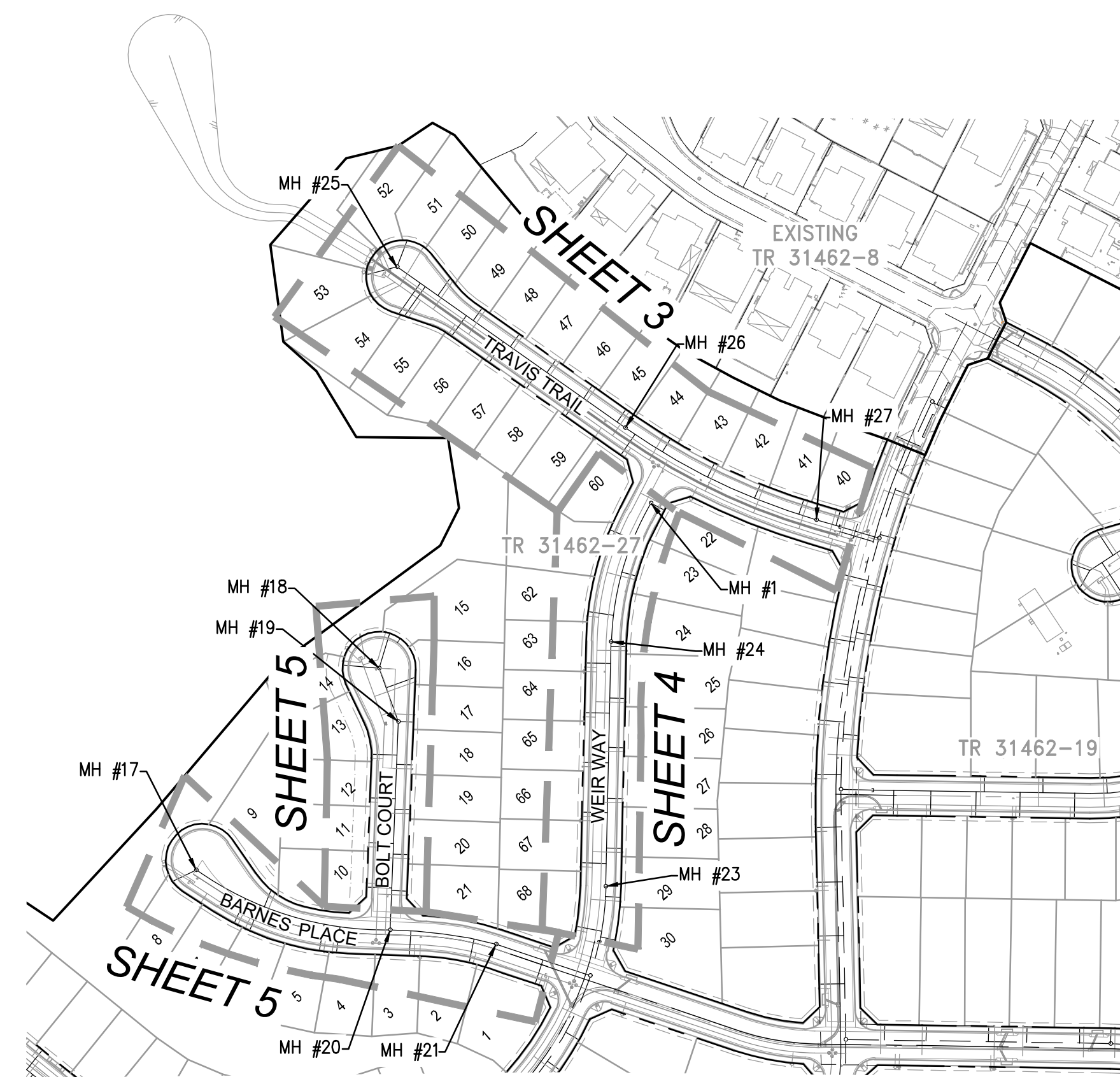

LEGEND

TRACT BOUNDARY	---	FS	FINISHED SURFACE
RIGHT OF WAY	----	INV	INVERT OF PIPE
PROPOSED SEWER MAIN	---	CL OR C	CENTERLINE
PROPOSED SEWER SERVICE	---	R/W	RIGHT-OF-WAY
PUBLIC UTILITY EASEMENT	---	LAT	LATERAL
CENTERLINE	---	STA	STATION
SEWER MANHOLE	○	PROP	PROPOSED
PROPOSED WATER MAIN	---	LENTH	LENGTH
PROPOSED WATER SERVICE	---	N.T.S.	NOT TO SCALE
PAD ELEVATION	2367.1	ELEV./EL.	ELEVATION
PROPOSED CATCH BASIN	⊞	MIN.	MINIMUM
SEWER LATERAL CALLOUT	10+14.37	MAX	MAXIMUM
CONSTRUCTION NOTE	Ⓟ	TYP.	TYPICAL
BACK FLOW PREVENTION DEVICE	Ⓛ	BOP	BOTTOM OF PIPE
		TOP	TOP OF PIPE
		M.H. OR MH	MANHOLE
		PVC	POLYVINYL CHLORIDE
		PIPE	INSIDE DIAMETER
		R.C.T.D.	RIVERSIDE COUNTY
		STD.	TRANS. DEPT.
		S.D.	STANDARD
		SWR OR SS	STORM DRAIN
		WTR	SEWER
		X-ING	CROSSING
		VCP	VITRIFIED CLAY
		PIPE	PIPE

LEGAL DESCRIPTION

THE LAND REFERRED TO HEREIN BELOW IS SITUATED IN THE CITY OF BEAUMONT, IN THE COUNTY OF RIVERSIDE, STATE OF CALIFORNIA, AND IS DESCRIBED AS FOLLOWS:

THE DESIGNATED REMAINDER PARCEL OF PARCEL MAP NO. 38090, IN THE CITY OF BEAUMONT, COUNTY OF RIVERSIDE, STATE OF CALIFORNIA, AS PER MAP RECORDED IN BOOK 254, PAGES 97 THROUGH 103, INCLUSIVE, OF PARCEL MAPS, RECORDS OF SAID COUNTY.

EXCEPTING THEREFROM THE ABOVE PARCEL ANY AND ALL NATURAL OIL, OIL RIGHTS, MINERALS, MINERAL RIGHTS, NATURAL GAS, NATURAL GAS RIGHTS AND OTHER HYDROCARBONS BY WHATSOEVER NAME KNOWN AND ALL RIGHTS THEREIN, GEOTHERMAL STEAM, AND ALL PRODUCTS DERIVED FROM ANY OF THE FOREGOING, THAT MAY BE WITHIN OR UNDER THE LAND, TOGETHER WITH THE PERPETUAL RIGHT OF DRILLING, MINING, EXPLORING AND OPERATING THEREFOR AND STORING IN AND REMOVING THE SAME FROM THE LAND OR ANY OTHER PROPERTY, INCLUDING THE RIGHT TO WHIPSTOCK OR DIRECTIONALLY DRILL AND MINE FROM PROPERTY OTHER THAN THE LAND, OIL OR GAS WELLS, TUNNELS AND SHAFTS INTO, THROUGH OR ACROSS THE SUBSURFACE OF THE LAND, AND TO BOTTOM SUCH WHIPSTOCKED OR DIRECTIONALLY DRILLED WELLS, TUNNELS AND SHAFTS UNDER AND BENEATH OR BEYOND THE EXTERIOR LIMITS THEREOF, AND TO REDRILL, RETUNNEL, EQUIP, MAINTAIN, REPAIR, DEEPEN AND OPERATE ANY SUCH WELLS, TUNNELS OR SHAFTS, WITHOUT THE RIGHT TO DRILL, MINE, STORE OR EXCAVATE THROUGH THE SURFACE OR THE UPPER 500 FEET OF THE SUBSURFACE OR THE LAND AS RESERVED BY OAK VALLEY PARTNERS, L.P., A TEXAS LIMITED PARTNERSHIP WHICH IS REGISTERED IN CALIFORNIA AS OVP, L.P., IN A GRANT DEED RECORDED NOVEMBER 14, 2003, AS INSTRUMENT NO. 2003-899365 OF OFFICIAL RECORDS.

SEWER CONSTRUCTION NOTES

- INSTALL 8" PVC (SDR-35) SEWER MAIN PIPE. 1,958 LF.
- INSTALL PRECAST 4' I.D. CONCRETE MANHOLE W/ CAST IRON MANHOLE COVER PER EMWD STD. DWG. SB-53 AND BEAUMONT STD. SB-51M. 7 EA.
- INSTALL 4" PVC SEWER HOUSE CONNECTION PER EMWD STD. DWG. SB-177. 1,626 LF.
- INSTALL LATERAL CLEANOUTS PER EMWD STD. DWG. SB-52. 59 EA.
- INSTALL 4" BACKFLOW PREVENTION DEVICE AMERICAN FOUNDRY'S NH53-A OR EQUAL. 22 EA.
- INSTALL TERMINUS MANHOLE PER SB-58. 4 EA.
- REMOVE 8" END CAP AND JOIN. 1 EA.

QTY:

"DECLARATION OF RESPONSIBLE CHARGE"

I HEREBY DECLARE THAT I AM THE ENGINEER OF WORK FOR THIS PROJECT, THAT I HAVE EXERCISED RESPONSIBLE CHARGE OVER THE DESIGN OF THE PROJECT AS DEFINED IN SECTION 6703 OF THE BUSINESS AND PROFESSIONS CODE, AND THAT THE DESIGN IS CONSISTENT WITH CURRENT STANDARDS. I UNDERSTAND THAT THE CHECK OF PROJECT DRAWINGS AND SPECIFICATIONS BY THE CITY OF BEAUMONT DOES NOT RELIEVE ME AS ENGINEER OF WORK OF MY RESPONSIBILITIES FOR PROJECT DESIGN.

FIRM: KIMLEY HORN & ASSOCIATES, INC.
ADDRESS: 3801 UNIVERSITY AVE. SUITE 300
CITY, ST.: RIVERSIDE, CA 92501
TELEPHONE: (760) 565-5146
BY: *Michael S. Sutton* R.C.E. NO.: C57667 DATE: _____

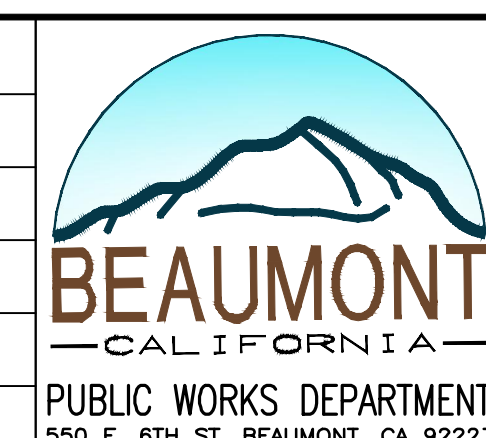

DESIGN BY: RS
DRAWN BY: MB
CHECKED BY: MS
SCALE: AS SHOWN
DATE: 6/2024
JOB NUMBER: _____

REVIEWED BY: *Michael S. Sutton* DATE: 12/2/2024
STAFF ENGINEER

RECOMMENDED BY: *Michael S. Sutton* DATE: 12/18/2024
PRINCIPAL ENGINEER

APPROVED BY: *Michael S. Sutton* DATE: 12/18/2024
CITY ENGINEER

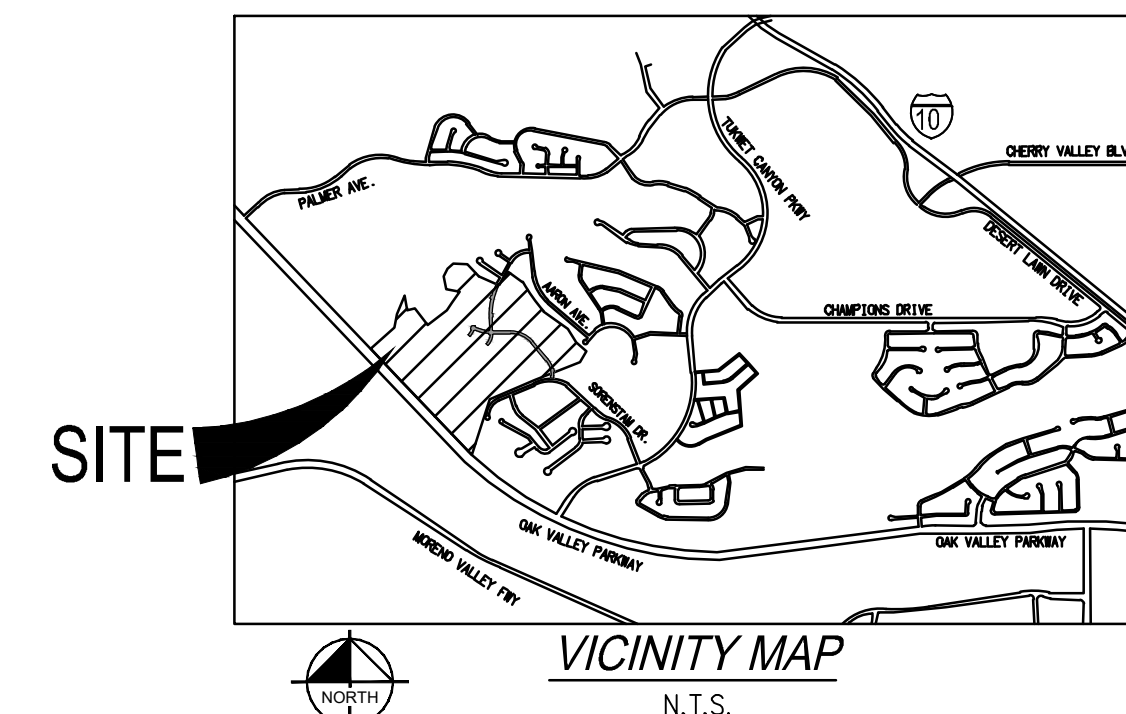

ABBREVIATIONS

OWNER/DEVELOPER

MERITAGE HOMES OF CALIFORNIA, A CALIFORNIA CORPORATION
5 PETERS CANYON ROAD, SUITE 310
IRVINE, CA 92606
ATTN: JOHANNA CROOKER
PHONE: (949) 299-3847

ENGINEER

KIMLEY-HORN & ASSOCIATES, INC.
3801 UNIVERSITY AVENUE, SUITE 300,
RIVERSIDE, CA 92501
ATTN: MICHAEL SUTTON
PHONE: (760) 565-5146
EMAIL: MIKE.SUTTON@KIMLEY-HORN.COM

ZONING/LAND USE

EXISTING ZONING: SFD (S.P. 318)
PROPOSED ZONING: SFD (S.P. 318)
EXISTING LAND USE: VACANT
PROPOSED LAND USE: SINGLE FAMILY RESIDENTIAL
SURROUNDING LAND USE: RESIDENTIAL/VACANT/GOLF COURSE

SOILS ENGINEER

ALTA CALIFORNIA GEOTECHNICAL, INC.
170 N MAPLE ST. SUITE 108
CORONA, CA 92880
ATTN: SCOTT GRAY
PHONE: (951) 509-7090

ANY AND ALL WATER, WATER RIGHTS OR INTERESTS THEREIN APPURTENANT OR RELATING TO THE LAND OR OWNED OR USED BY GRANITOR IN CONNECTION WITH OR WITH RESPECT TO THE LAND (NO MATTER HOW ACQUIRED BY GRANITOR), WHETHER SUCH WATER RIGHTS SHALL BE RIPARIAN, OVERLYING, APPROPRIATIVE, LITTORAL, PERCOLATING, PRESCRIPTIVE, ADJUDICATED, STATUTORY OR CONTRACTUAL, TOGETHER WITH THE RIGHT AND POWER TO EXPLORE, DRILL, REMOVE AND RESTORE THE SAME FROM OR IN THE LAND OR TO DIVERT OR OTHERWISE UTILIZE SUCH WATER, RIGHTS OR INTERESTS ON ANY OTHER PROPERTY OWNED BY OR LEASED BY GRANITOR, WITHOUT THE RIGHT TO ENTER UPON THE SURFACE OF THE LAND IN THE EXERCISE OF SUCH RIGHTS; PROVIDED, HOWEVER, ONLY IF AND TO THE EXTENT THAT SUCH RIGHTS ARE NOT USED BY GRANTEE IN ITS USE AND ENJOYMENT OF THE LAND AS RESERVED BY OAK VALLEY PARTNERS, L.P., A TEXAS LIMITED PARTNERSHIP, WHICH IS REGISTERED IN CALIFORNIA AS OVP, L.P., IN A GRANT DEED RECORDED NOVEMBER 14, 2003 AS INSTRUMENT NO. 2003-899365 OF OFFICIAL RECORDS.

APN: 413-790-010

NOTE

- APPROVAL OF THESE PLANS APPLIES ONLY WITHIN THE JURISDICTION OF THE CITY OF BEAUMONT.
- TRENCHING FOR UTILITIES AND STRUCTURES IS NOT ALLOWED UNTIL SOIL COMPACTION REPORT IS SUBMITTED AND APPROVED BY THE PUBLIC WORKS DEPARTMENT.
- THE CITY RESERVES THE RIGHT TO REQUIRE REVISION OF THE APPROVED PLANS TO CONFORM WITH CURRENT STANDARDS AND TO POST A NEW BOND IF CONSTRUCTION HAS NOT COMMENCED WITHIN TWO YEARS AFTER PLANS WERE APPROVED.
- SIDEWALK AND DRIVEWAY APPROACHES WILL BE POURED/CONSTRUCTED ONLY AFTER DRIVEWAY LOCATIONS ARE DETERMINED.

INDEX OF SHEETS	
SHEET NO.	SHEET TITLE
1	TITLE SHEET
2	TYPICAL SECTIONS
3	TRAVIS TRAIL
4	WEIR WAY
5	BARNES PLACE AND BOLT COURT

ALL STANDARD DRAWINGS ARE COUNTY OF RIVERSIDE ROAD IMPROVEMENT STANDARDS & SPECIFICATIONS UNLESS NOTED OTHERWISE:
* RCF&WCD STANDARD MANUAL
** EMWD SEWER STANDARD DRAWINGS
*** STANDARD PLANS FOR PUBLIC WORKS CONSTRUCTION



BENCHMARK:
USGS - MONUMENT "REST"
BENCHMARK DISK SET IN TOP OF CONCRETE MONUMENT STAMPED "REST 1972" ON DESERT LAWN DR. ACROSS THE DRIVE CENTERLINE 24.9 FT. SOUTHWEST OF THE SOUTHWEST EDGE OF THE SOUTHEAST BOUND LANES OF INTERSTATE HIGHWAY 10
88 DATUM
ELEV. = 2494.16

BY	MARK	DESCRIPTION	APPR.	DATE
ENGINEER	REVISIONS			CITY

Kimley»Horn
© 2019 KIMLEY-HORN AND ASSOCIATES, INC.
3801 UNIVERSITY AVE. SUITE 300, RIVERSIDE, CA 92501
PHONE: 951-543-9868

MIKE S. SUTTON
R.C.E. NO.: C57667

DESIGN BY: RS
DRAWN BY: MB
CHECKED BY: MS
SCALE: AS SHOWN
DATE: 6/2024
JOB NUMBER: _____

REVIEWED BY: *Michael S. Sutton* DATE: 12/2/2024
STAFF ENGINEER

RECOMMENDED BY: *Michael S. Sutton* DATE: 12/18/2024
PRINCIPAL ENGINEER

APPROVED BY: *Michael S. Sutton* DATE: 12/18/2024
CITY ENGINEER

CITY OF BEAUMONT, CALIFORNIA
SEWER IMPROVEMENT PLANS FOR:
TRACT 31462-27
TITLE SHEET

SHEET
1
OF 5 SHEETS
FILE NO: 3506
PW2024-0036

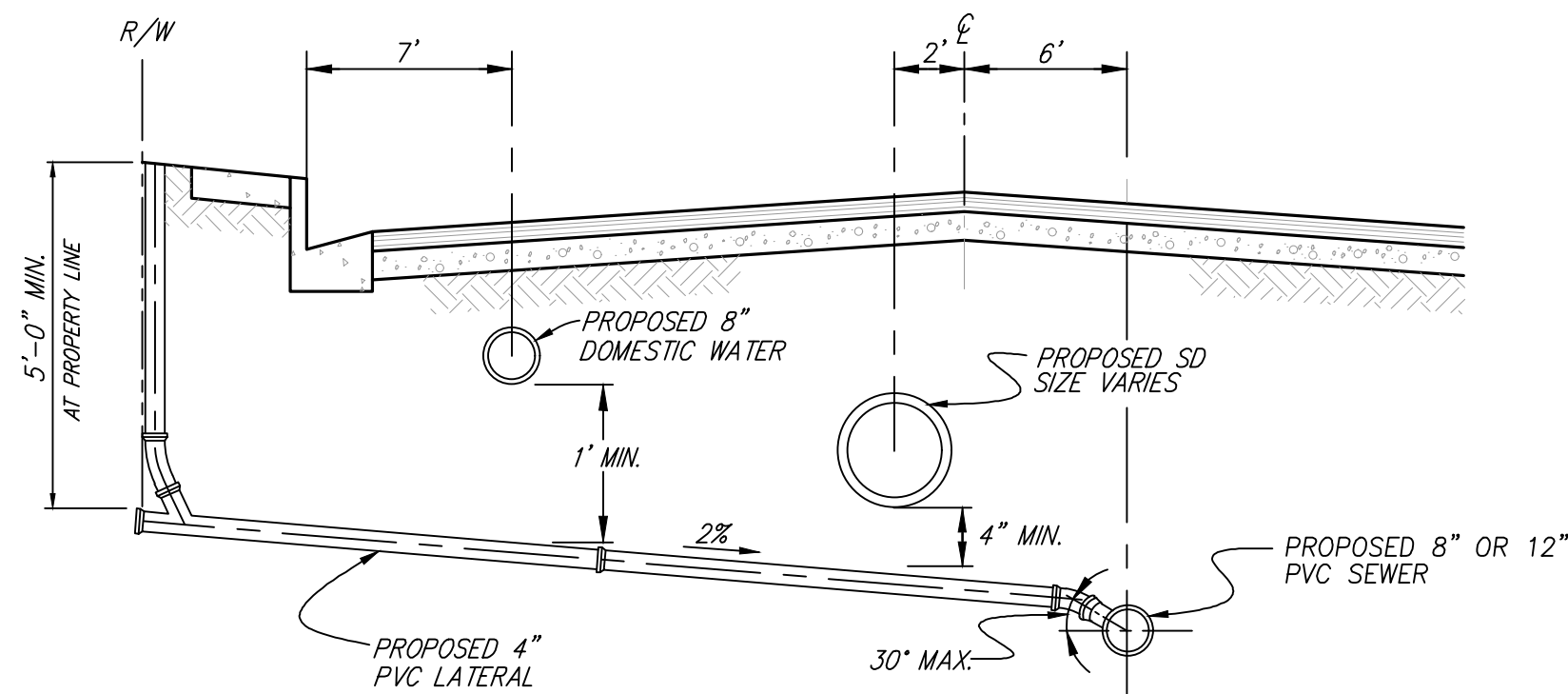
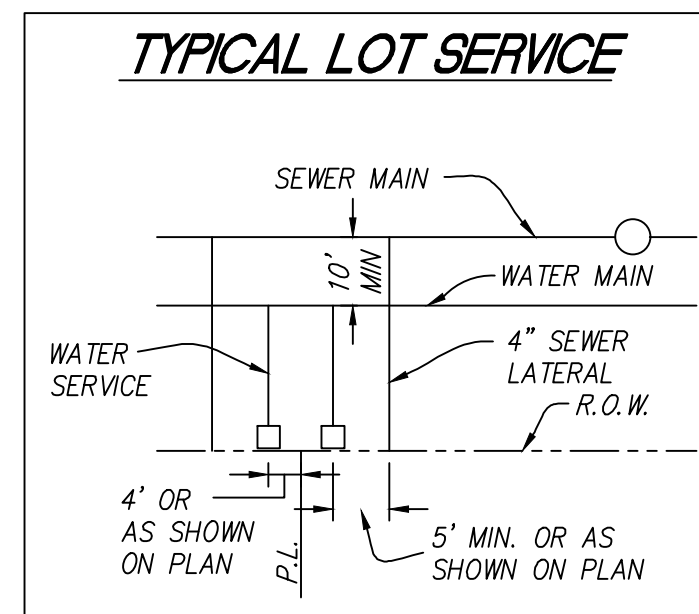
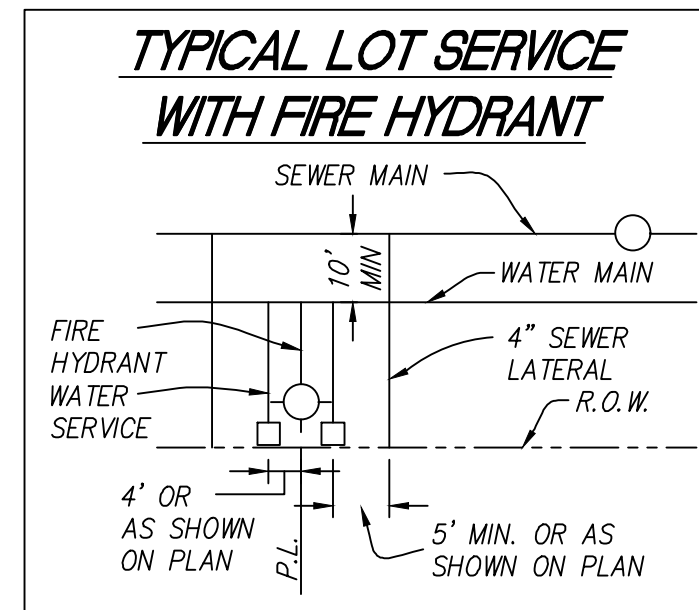

DETAIL A - TYPICAL LATERAL UNDER SD DETAIL

NOT TO SCALE
(REFERENCE E.M.W.D. STD. DWG. SB-177)
NOTE: CONSTRUCT 4" LATERAL AT 2% MIN SLOPE

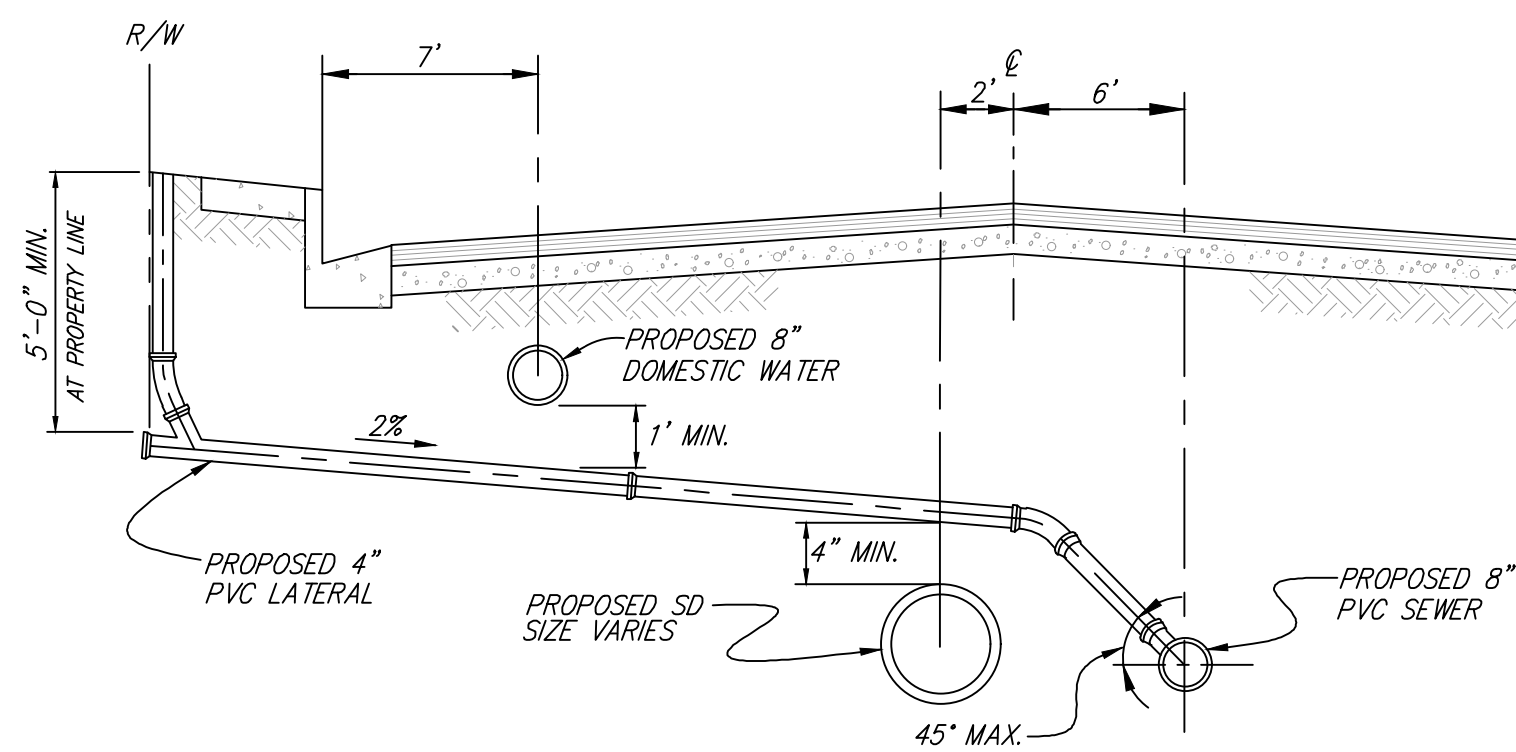

DETAIL B - TYPICAL LATERAL OVER SD DETAIL

NOT TO SCALE
(REFERENCE E.M.W.D. STD. DWG. SB-177)
NOTE: CONSTRUCT 4" LATERAL AT 2% MIN SLOPE

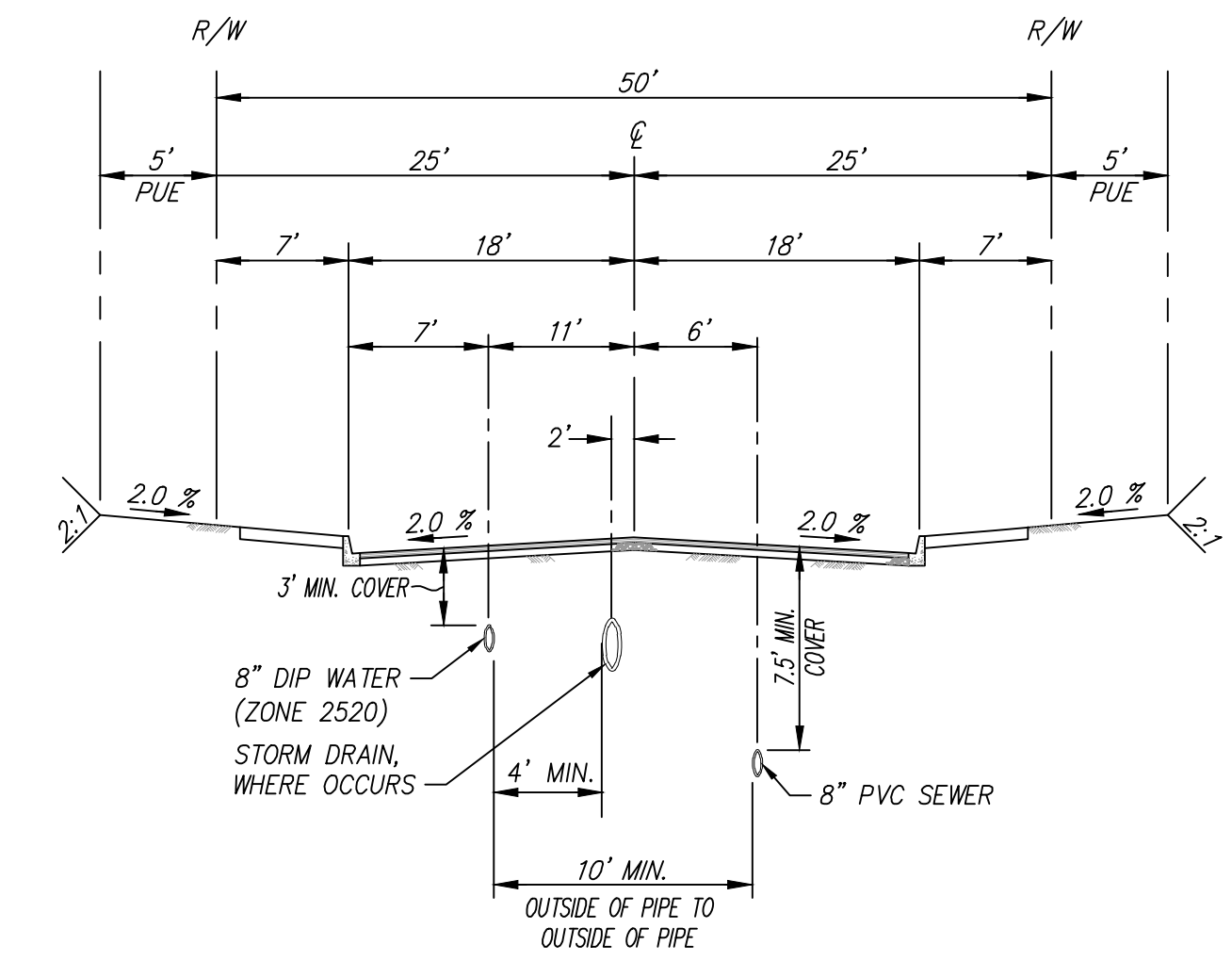

TYPICAL STREET SECTION

N.T.S.

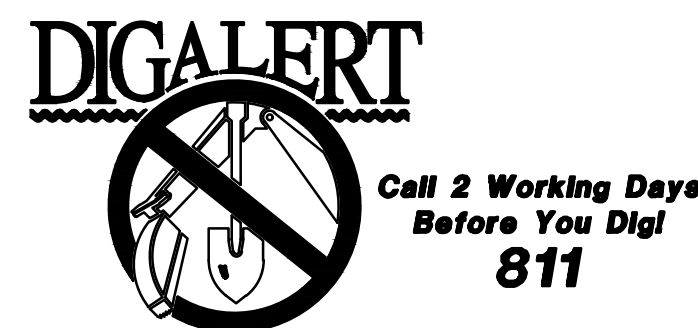

BENCHMARK:
USGS - MONUMENT "REST"
BENCHMARK DISK SET IN TOP OF
CONCRETE MONUMENT STAMPED "REST
1972" ON DESERT LAWN DR. ACROSS
THE DRIVE CENTERLINE 24.9 FT.
SOUTHWEST OF THE SOUTHWEST EDGE
OF THE SOUTHWEST BOUND LANES OF
INTERSTATE HIGHWAY 10
88 DATUM
ELEV. = 2494.16

BY	MARK	DESCRIPTION	APPR.	DATE
ENGINEER		REVISIONS		CITY

Kimley»Horn
© 2019 KIMLEY-HORN AND ASSOCIATES, INC.
3801 UNIVERSITY AVE. SUITE 300, RIVERSIDE, CA 92501
PHONE: 951-543-9868

M. S. Sutton
MIKE S. SUTTON
R.C.E. NO: C57667

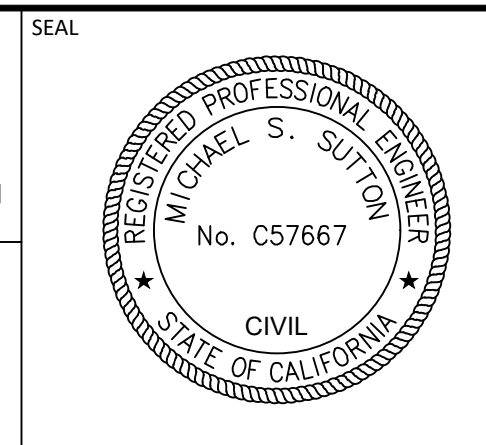

DESIGN BY: RS
DRAWN BY: MB
CHECKED BY: MS
SCALE: AS SHOWN
DATE: 6/2024
JOB NUMBER:

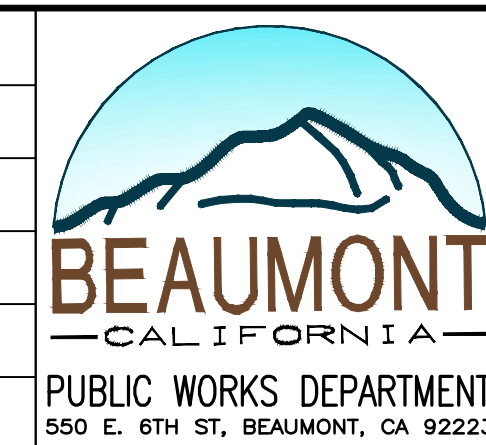

REVIEWED BY: *[Signature]* DATE: 12/2/2024
STAFF ENGINEER

RECOMMENDED BY: *[Signature]* DATE: 12/18/2024
PRINCIPAL ENGINEER

APPROVED BY: *[Signature]* DATE: 12/18/2024
CITY ENGINEER

CITY OF BEAUMONT, CALIFORNIA
SEWER IMPROVEMENT PLANS FOR:
TRACT 31462-27
TYPICAL SECTIONS
FAIRWAY CANYON - 4C

SHEET
2
OF 5 SHEETS
FILE NO: 3506
PW2024-0036

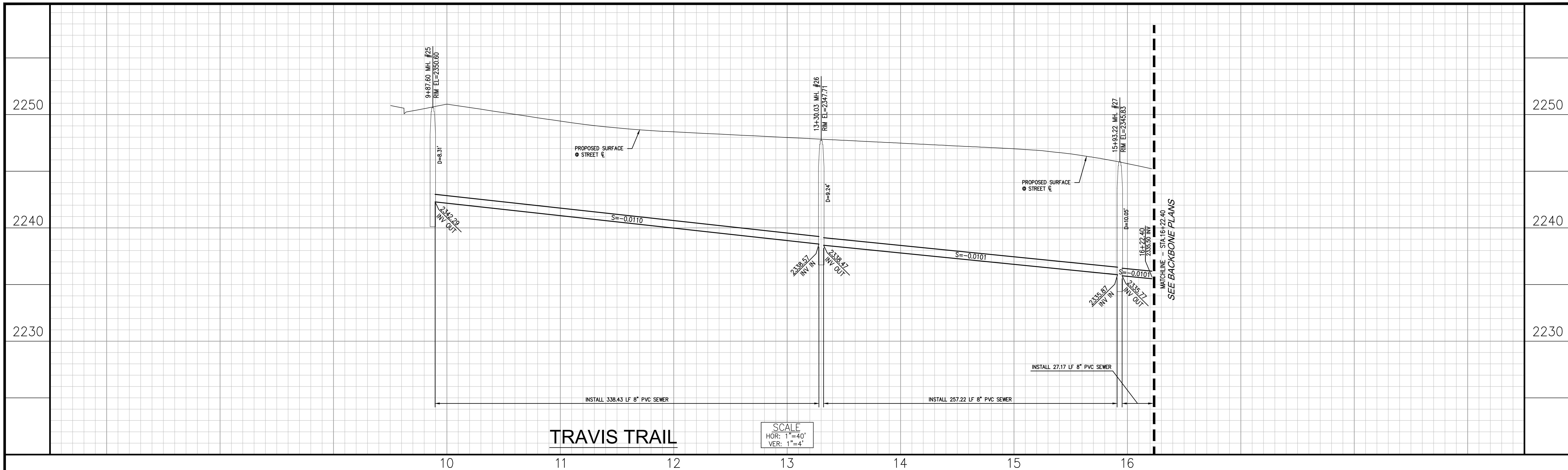

TRAVIS TRAIL

SCALE
HOR: 1"=40'
VER: 1"=4'

CONSTRUCTION NOTES

- 1 INSTALL 8" PVC (SDR-35) SEWER MAIN PIPE.
- 2 INSTALL PRECAST 4' I.D. CONCRETE MANHOLE W/ CAST IRON MANHOLE COVER PER EMWD STD. DWG. SB-53 AND BEAUMONT STD. SB-51M.
- 3 INSTALL 4" PVC SEWER HOUSE CONNECTION PER EMWD STD. DWG. SB-177.
- 5 INSTALL LATERAL CLEANOUTS PER EMWD STD. DWG. SB-52
- 6 INSTALL 4" BACKFLOW PREVENTION DEVICE AMERICAN FOUNDRY'S NH53-A OR EQUAL.
- 7 INSTALL TERMINUS MANHOLE PER SB-58.

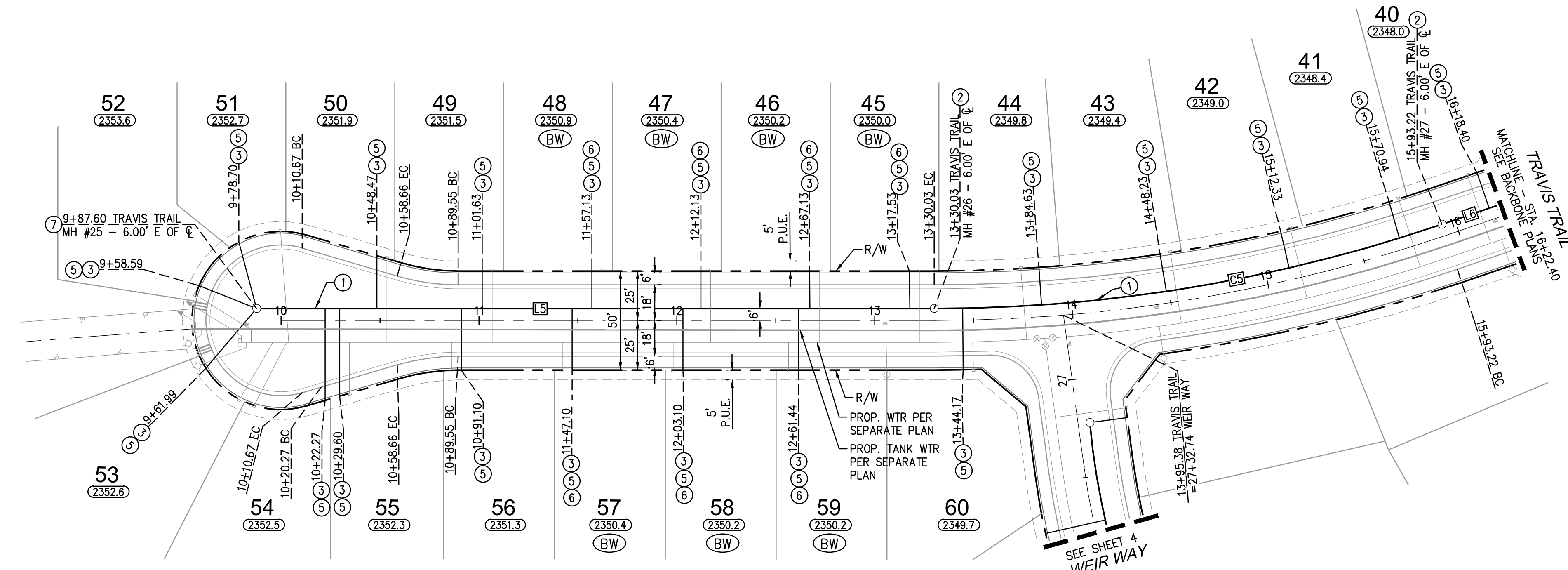

LINE AND CURVE TABLE				
NO.	LENGTH	RADIUS	BEARING/DELTA	TANGENT
C5	257.22'	794.00'	18°33'41"	129.75'
L5	338.43'		N52°56'21"W	
L6	27.17'		N71°47'21"W	

TRAVIS TRAIL

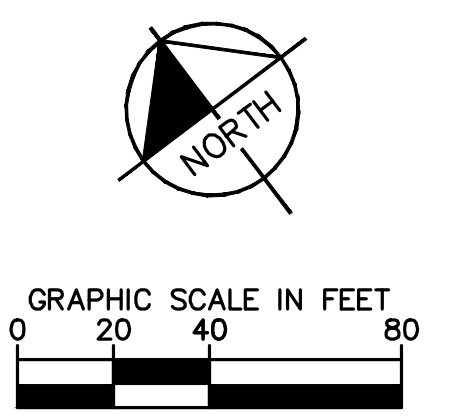

BENCHMARK:
USGS - MONUMENT "REST"
BENCHMARK DISK SET IN TOP OF
CONCRETE MONUMENT STAMPED "REST
1972" ON DESERT LAWN DR. ACROSS
THE DRIVE CENTERLINE 24.9 FT.
SOUTHWEST OF THE SOUTHWEST EDGE
OF INTERSTATE HIGHWAY 10
88 DATUM
ELEV. = 2494.16

BY	MARK	DESCRIPTION	APPR.	DATE
ENGINEER		REVISIONS		CITY

Kimley»Horn
© 2019 KIMLEY-HORN AND ASSOCIATES, INC.
3801 UNIVERSITY AVE. SUITE 300, RIVERSIDE, CA 92501
PHONE: 951-543-9868

M. S. SUTTON
R.C.E. NO: C57667

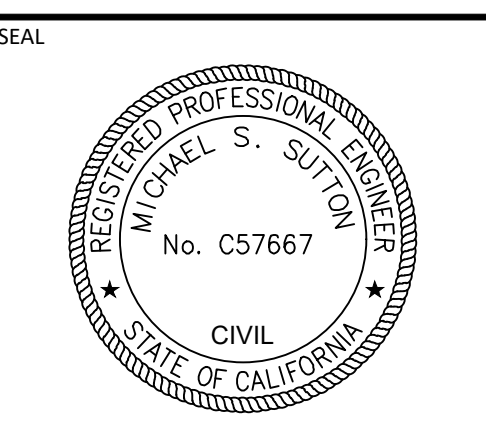

DESIGN BY: RS
DRAWN BY: MB
CHECKED BY: MS
SCALE: AS SHOWN
DATE: 6/2024
JOB NUMBER: PUBLIC WORKS DEPARTMENT
550 E. 6TH ST, BEAUMONT, CA 92223



REVIEWED BY: *[Signature]* DATE: 12/2/2024
STAFF ENGINEER

RECOMMENDED BY: *[Signature]* DATE: 12/18/2024
PRINCIPAL ENGINEER

APPROVED BY: *[Signature]* DATE: 12/18/2024
CITY ENGINEER

CITY OF BEAUMONT, CALIFORNIA
SEWER IMPROVEMENT PLANS FOR:
TRACT 31462-27
TRAVIS TRAIL
FAIRWAY CANYON - 4C

SHEET
3
OF 5 SHEETS
FILE NO:
3506
PW2024-0036

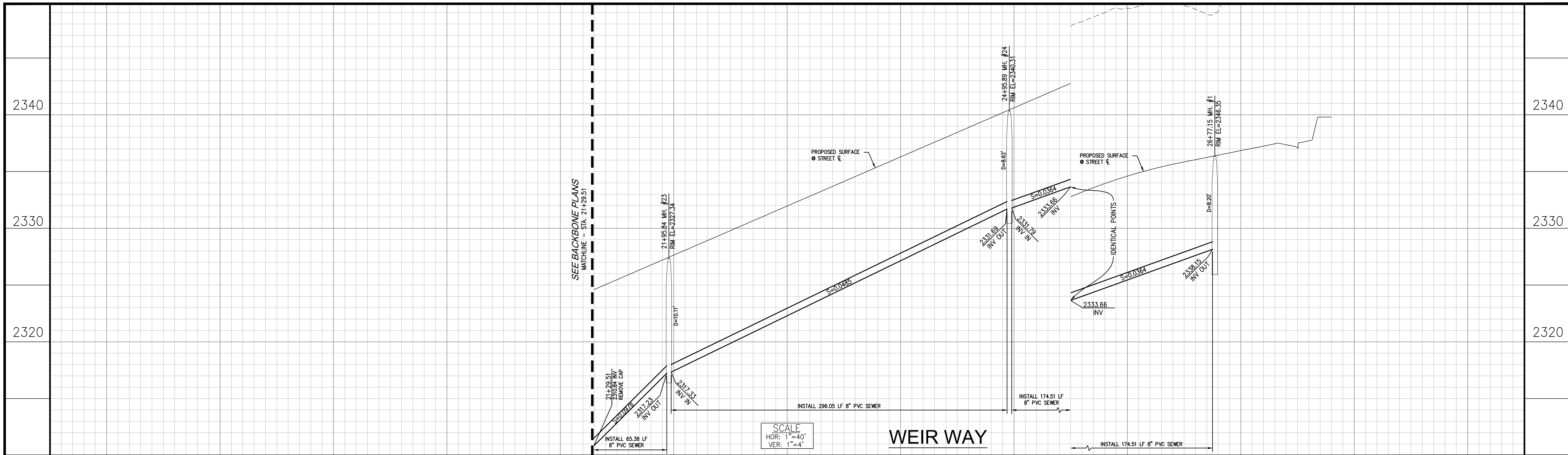

CONSTRUCTION NOTES

- ① INSTALL 8" PVC (SDR-35) SEWER MAIN PIPE.
- ② INSTALL PRECAST 4' I.D. CONCRETE MANHOLE W/ CAST IRON MANHOLE COVER PER EMWD STD. DWG. SB-53 AND BEAUMONT STD. SB-51M.
- ③ INSTALL 4" PVC SEWER HOUSE CONNECTION PER EMWD STD. DWG. SB-177.
- ④ INSTALL LATERAL CLEANOUTS PER EMWD STD. DWG. SB-52
- ⑤ INSTALL 4" BACKFLOW PREVENTION DEVICE AMERICAN FOUNDARY'S NH53-A OR EQUAL.
- ⑥ INSTALL TERMINUS MANHOLE PER SB-58.
- ⑦ REMOVE 8" END CAP AND JOIN.

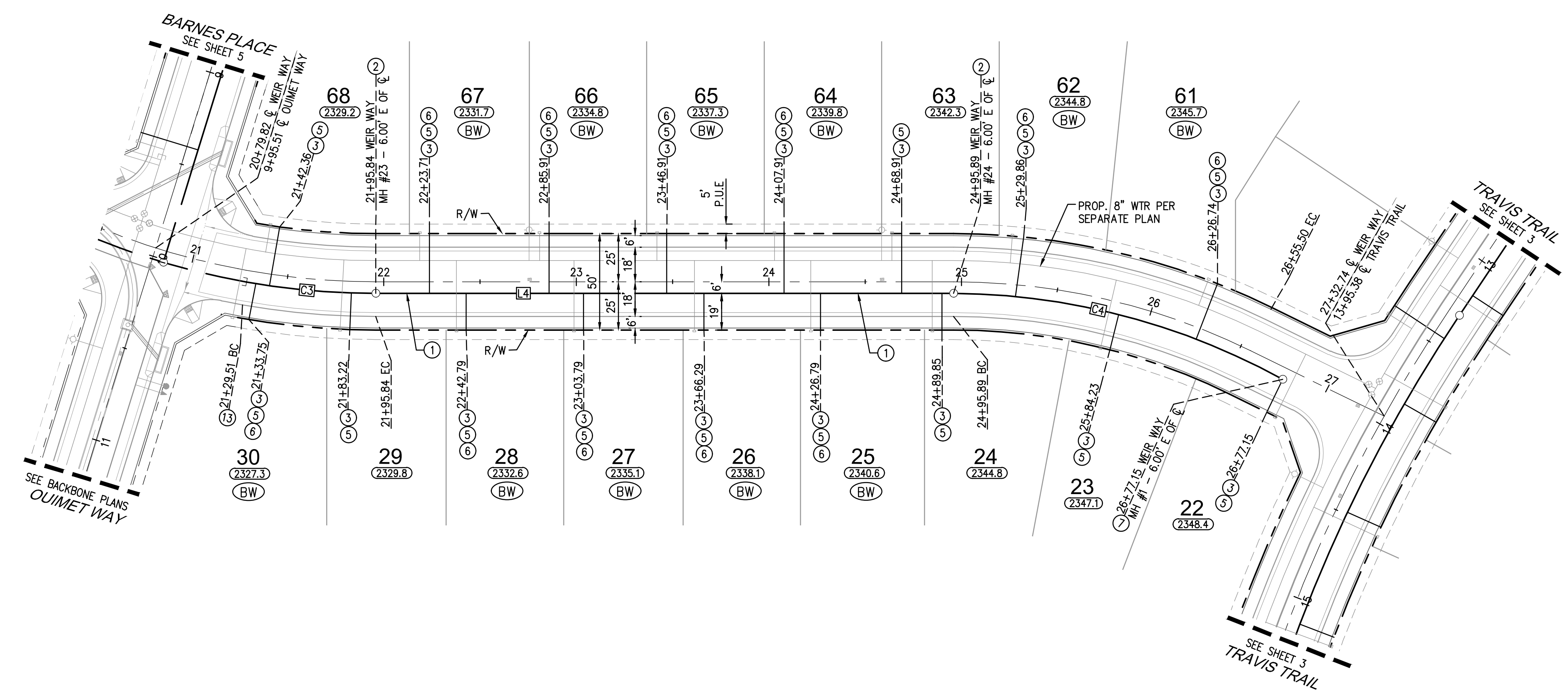

LINE AND CURVE TABLE				
NO.	LENGTH	RADIUS	BEARING/DELTA	TANGENT
C3	65.38'	386.00'	9°42'17"	32.77'
C4	174.51'	359.36'	27°49'23"	89.01'
L4	296.05'		N03°13'15"E	

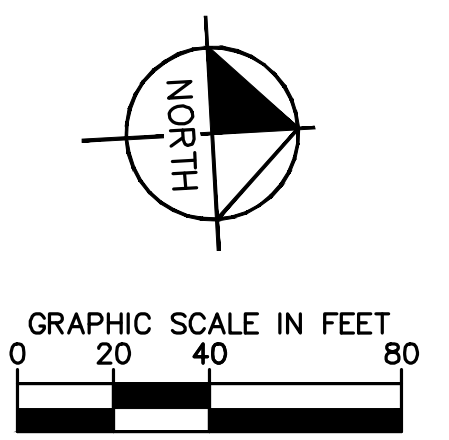

	<p>BENCHMARK: USGS - MONUMENT "REST" BENCHMARK DISK SET IN TOP OF CONCRETE MONUMENT STAMPED "REST 1972" ON DESERT LAWN DR. ACROSS THE DRIVE CENTERLINE 24.9 FT. SOUTHWEST OF THE SOUTHWEST EDGE OF THE SOUTHWEST BOUND LANES OF INTERSTATE HIGHWAY 10 88 DATUM ELEV. = 2494.16</p>	<p>© 2019 KIMLEY-HORN AND ASSOCIATES, INC. 3801 UNIVERSITY AVE. SUITE 300, RIVERSIDE, CA 92501 PHONE: 951-543-9868</p>		<p>DESIGN BY: RS DRAWN BY: MB CHECKED BY: MS SCALE: AS SHOWN DATE: 6/2024 JOB NUMBER: PUBLIC WORKS DEPARTMENT 550 E. 6TH ST., BEAUMONT, CA 92223</p>	<p>PUBLIC WORKS DEPARTMENT 550 E. 6TH ST., BEAUMONT, CA 92223</p>	<p>REVIEWED BY: DATE: 12/2/2024 STAFF ENGINEER</p> <p>RECOMMENDED BY: DATE: 12/18/2024 PRINCIPAL ENGINEER</p> <p>APPROVED BY: DATE: 12/18/2024 CITY ENGINEER</p>	<p>CITY OF BEAUMONT, CALIFORNIA SEWER IMPROVEMENT PLANS FOR: TRACT 31462-27 WEIR WAY FAIRWAY CANYON - 4C</p>	<p>SHEET 4 OF 5 SHEETS FILE NO: 3506 PW2024-0036</p>														
	<table border="1" style="width: 100%; border-collapse: collapse;"> <thead> <tr> <th>BY</th> <th>MARK</th> <th>DESCRIPTION</th> <th>APPR.</th> <th>DATE</th> </tr> </thead> <tbody> <tr> <td> </td> <td> </td> <td> </td> <td> </td> <td> </td> </tr> <tr> <td> </td> <td> </td> <td> </td> <td> </td> <td> </td> </tr> </tbody> </table>	BY	MARK	DESCRIPTION	APPR.	DATE											<p style="text-align: center;">WEIR WAY</p>					
BY	MARK	DESCRIPTION	APPR.	DATE																		

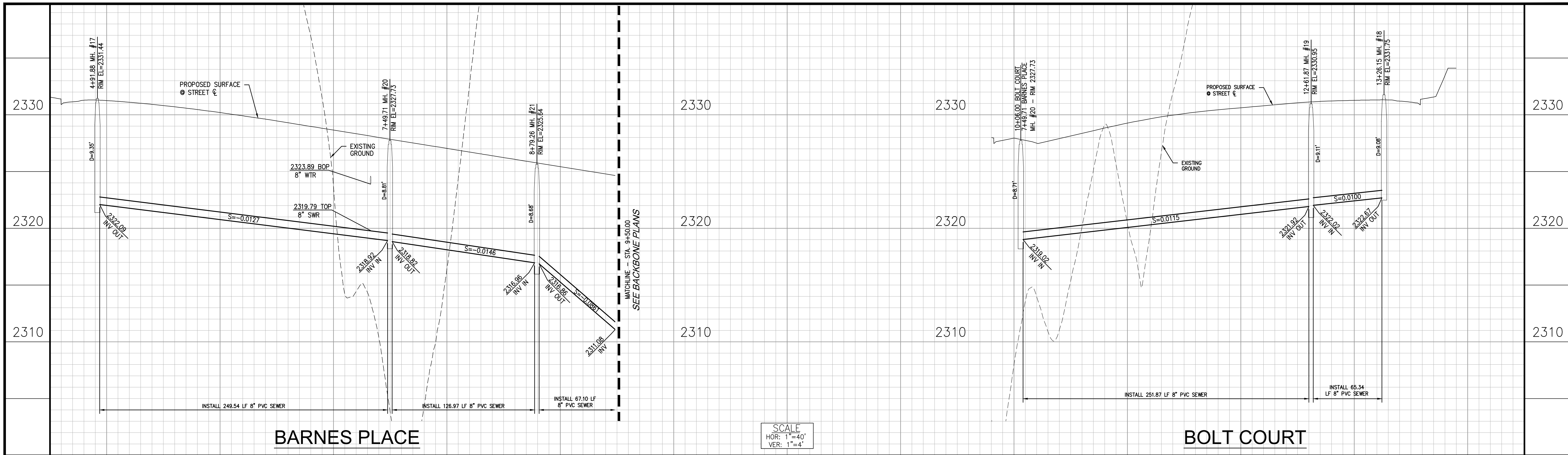

BARNES PLACE

BOLT COURT

SCALE
HOR: 1"=40'
VER: 1"=4'

5 6 7 8 9 10 10 11 12 13

CONSTRUCTION NOTES

- 1 INSTALL 8" PVC (SDR-35) SEWER MAIN PIPE.
- 2 INSTALL PRECAST 4' I.D. CONCRETE MANHOLE W/ CAST IRON MANHOLE COVER PER EMWD STD. DWG. SB-53 AND BEALMONT STD. SB-51M.
- 3 INSTALL 4" PVC SEWER HOUSE CONNECTION PER EMWD STD. DWG. SB-177.
- 5 INSTALL LATERAL CLEANOUTS PER EMWD STD. DWG. SB-52
- 6 INSTALL 4" BACKFLOW PREVENTION DEVICE AMERICAN FOUNDARY'S NH53-A OR EQUAL.
- 7 INSTALL TERMINUS MANHOLE PER SB-58.

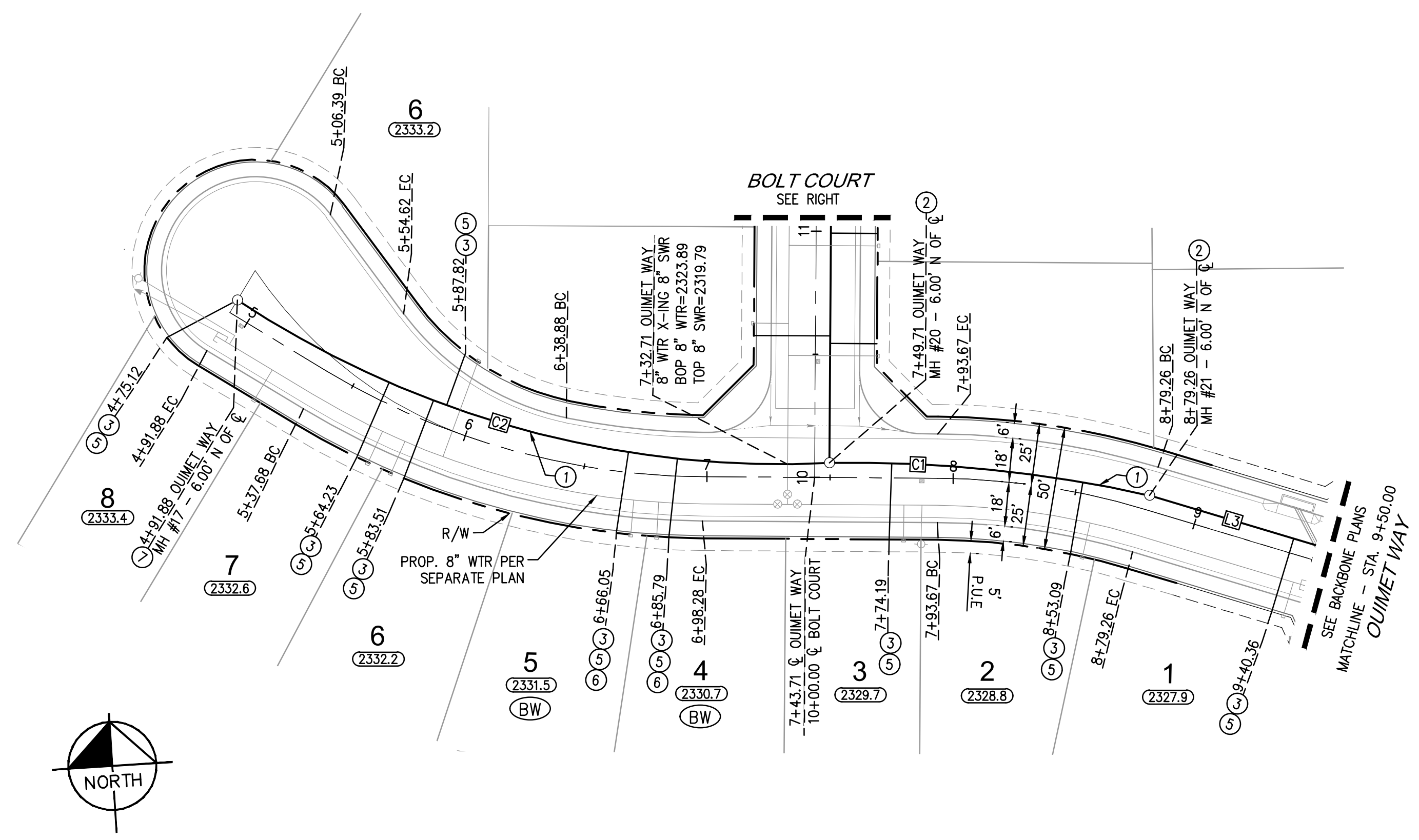

BARNES PLACE

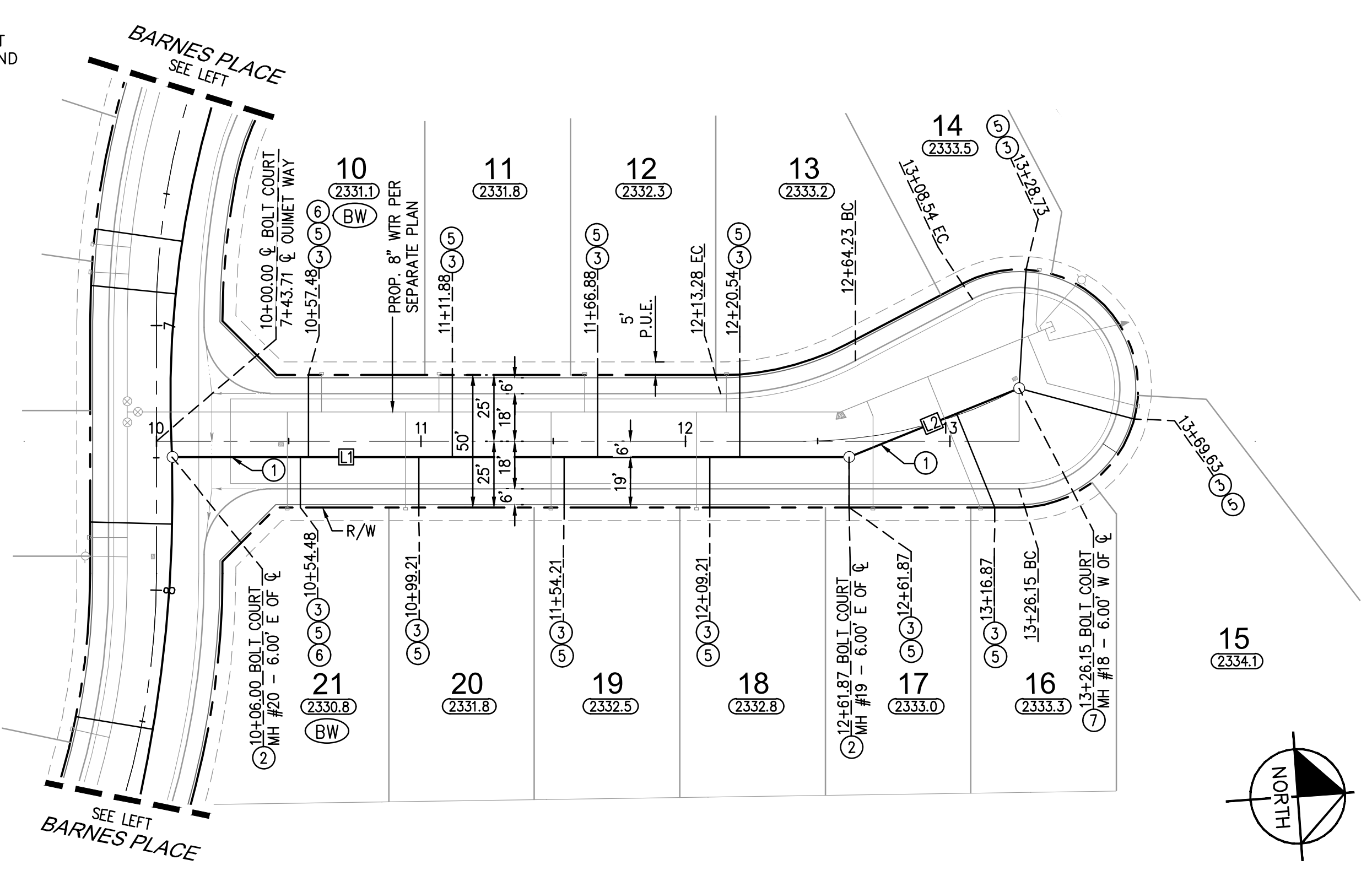

BOLT COURT

LINE AND CURVE TABLE

NO.	LENGTH	RADIUS	BEARING/DELTA	TANGENT
C1	126.97'	541.00'	13°26'50"	63.78'
C2	249.54'	400.00'	35°44'35"	128.98'
L1	251.87'		N04°04'37"E	
L2	65.34'		N17°56'44"W	
L3	67.10'		N69°34'39"W	

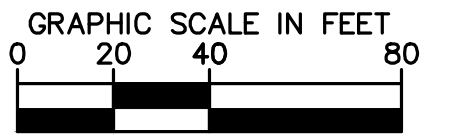
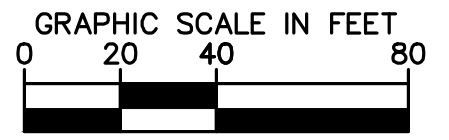

BENCHMARK:
USGS - MONUMENT "REST"
BENCHMARK DISK SET IN TOP OF
CONCRETE MONUMENT STAMPED "REST
1972" ON DESERT LAWN DR. ACROSS
THE DRIVE CENTERLINE 24.9 FT.
SOUTHWEST OF THE SOUTHWEST EDGE
OF THE SOUTHWEST BOUND LANES OF
INTERSTATE HIGHWAY 10
88 DATUM
ELEV. = 2494.16

BY	MARK	DESCRIPTION	APPR.	DATE
ENGINEER		REVISIONS		CITY

Kimley»Horn
© 2019 KIMLEY-HORN AND ASSOCIATES, INC.
3801 UNIVERSITY AVE. SUITE 300, RIVERSIDE, CA 92501
PHONE: 951-543-9868

M. S. SUTTON
R.C.E. NO. C57667

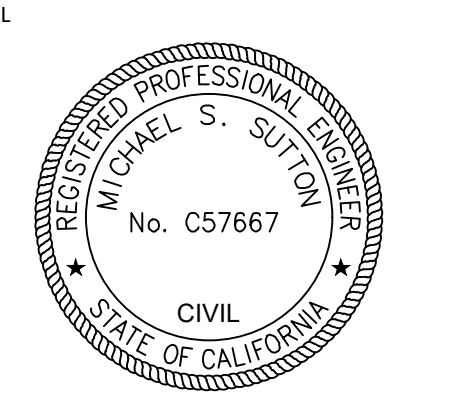

DESIGN BY: RS
DRAWN BY: MB
CHECKED BY: MS
SCALE: AS SHOWN
DATE: 6/2024
JOB NUMBER: PUBLIC WORKS DEPARTMENT
550 E. 6TH ST., BEAUMONT, CA 92223

REVIEWED BY: [Signature] DATE: 12/2/2024
STAFF ENGINEER

RECOMMENDED BY: [Signature] DATE: 12/18/2024
PRINCIPAL ENGINEER

APPROVED BY: [Signature] DATE: 12/18/2024
CITY ENGINEER

CITY OF BEAUMONT, CALIFORNIA
SEWER IMPROVEMENT PLANS FOR:
TRACT 31462-27
BARNES PLACE AND BOLT COURT
FAIRWAY CANYON - 4C

SHEET
5
OF 5 SHEETS
FILE NO: 3506
PW2024-0036